

04/2024

VM VERLAG  
Cologne /Germany



# EXTRUSION INTERNATIONAL

USA



Solutions for circular economy –  
aglomEX series  
The innovative way of pelletizing extrusion.  
[www.battenfeld-cincinnati.com](http://www.battenfeld-cincinnati.com)

Process engineering for  
efficient plastics extrusion  
of tomorrow.

battenfeld-cincinnati   
a Davis-Standard Company

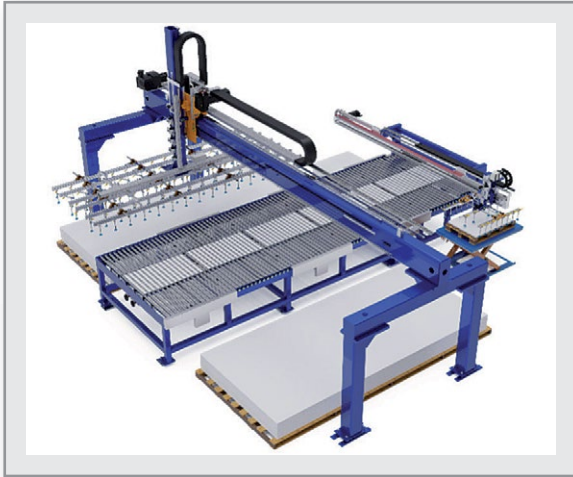

### Plate Stacking Machine

for automatic depositing of your production plates on transport pallets or trolleys.

Optional available with:

- Additional stacking places
- Spreading device of sheets side by side
- Separation of consecutive panels for simultaneous stacking

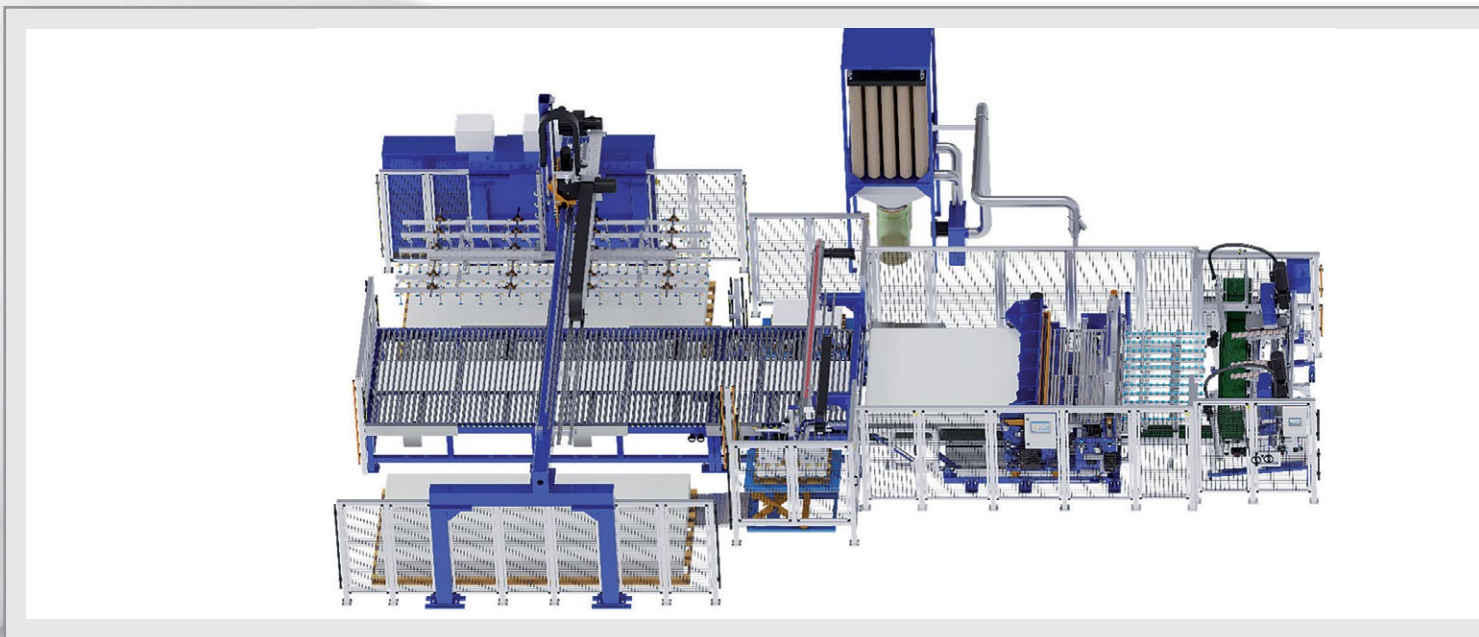

### Cross Cutting Combination

enables optional sawing or cutting in one machine.

Optional available with:

- Hydraulic driven scissor
- Electric driven scissor
- Cross Cut Mill instead of saw
- Cutting angle adjustment



Made in  
Germany

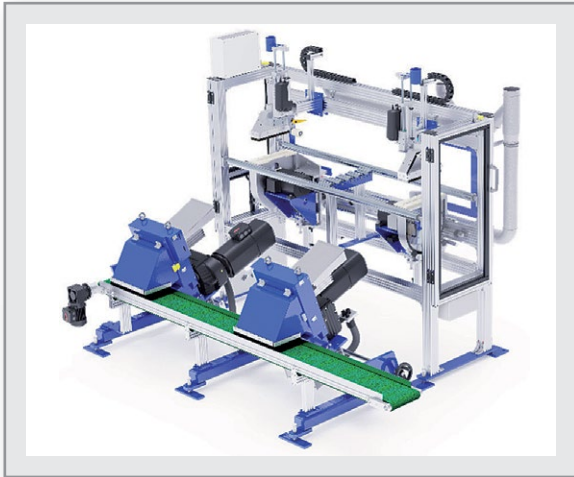

### Edge Trimming Saw & Trim Strip Chopper

an unbeatable team for longitudinal cutting of your panel and direct shredding of the resulting return material.

The machines are also offered individually with many options.

As a specialist in the field of special machine construction, we always find a solution!



### Pull Off Roller

provides precise regulation and compliance of roller speed and roller force.

#### Optional available with:

- Automatic material run control
- Selection of roller coatings
- Multiple Pull Off Roller version

### Calender

for continuous dimensional accuracy and surface quality.

#### Key data:

- Throughput capacity depending on material 400 - 1300 kg/h
- Line speed 0,5 - 70 m/min
- Line pressure per roller: 100-1300 N/cm



### STEIN Maschinenbau GmbH & Co. KG

Wartbachstrasse 9  
66999 Hinterweidenthal/Germany  
Tel. (+49) (0)63 96-9215-0  
Fax (+49) (0)63 96-9215-25  
stein@stein-maschinenbau.de  
www.stein-maschinenbau.de

## CONTENTS

Firms in this issue	6	Statement on White House Federal Action	
Imprint	7	Announcement	29
<b>Industry News</b>	8	White House Position Change on Plastic	
Calendar	8	Production Caps Strongly Opposed	29
Materials, Processes, Energy: the Focus		Leadership Change at US Site Announced	30
is on Efficiency at Fakuma 2024	8	RealClearEnergy Features NCSL Op-ed	30
Great Interest in K 2025	9	Keynote Speaker Announced for	
GREENPLAST 2025	10	Inaugural 2024 National Plastics Conference	31
Inline Inspection of Polarizer Films	11	Enhanced Website to Elevate	
Acquisition	12	Customer Experience Launched	31
Shanghai World of Packaging (swop) 2024	13	Innovations in Conductive Additives	
AMAPLAST ASSEMBLY – The Federation		Showcased at 2024 IWCS Cable &	
project takes off	14	Connectivity Industry Forum	32
Precision Gravimetric Dosing & Mixing	15	New Plastics Demand Estimate Report Launched	32
Dedicated Low Density Film for		In-Mould Film Solution for Large	
Ice Cream Flow Wrap Packaging Launched	16	Format Containers Launched	33
2-Meter Stretch Wrap Film Line –		Statement on White House Policy	
Fully Revised and Extended	16	Change Featured	33
„German Innovation Award“	17	<b>Extrusion Tooling</b>	
Smart Length Measurement	18	PO 4 400 CR – A Flexible Cross Head System for	
of Hoses and Tubes	18	Barrier Pipes up to 400 mm	34
New Standards in Diameter Measurement	18	<b>Bottle-to-Bottle Recycling – Case Study</b>	
Operation Clean Sweep Certification Achieved	19	PET Bottle Recycling Solution	
18 Micrometer Thin MDO-PE Film Launched	20	from a Single Source	36
Servomotor-Driven Edge Trimming		<b>Recycling – Case Study</b>	
System for Sheet and Film Extrusion	21	Strong Partnership Drives Plastics	
Plastics Recycling Award Europe 2024	22	Recycling in China	37
New Cam-Lock Design Introduced	22	<b>Measurement Technology</b>	
UMAC® – Ultrasonic Measurement		Quality Assurance Transformation: Radar	
& Control Systems	23	Technology Is Breaking Barriers toward	
Subsidiary in Bharat (India) Founded	23	Sustainability and Automation via	
Realignment	24	Wall Thickness Measurements	38
Investment in upgrade Alpha Carbone Facility	25	<b>Foam Extrusion</b>	
Subsidiary Opened	24	Risk-free Process Optimization – Testing System	
Sales Engineer for Fluid Coatings in China		Precisely Meters Different Blowing Agents	
Appointed	26	Even with Fluctuating Extruder Pressure	42
New Compostable Products	26	<b>Periphery</b>	
New Product Line	27	Cutting Rotor KRONOS-MAX in the Spotlight	43
Lightweight Tubes for Electric Vehicles	27	<b>Measurement Technology – Case Study</b>	
<b>Industry News USA</b>	28	„Monitoring the Manufacturing Process	
Analysis Released: Impact of Fed Policy on Housing		Helps Us to Significantly Reduce Scrap“	44
and Plastics	28	<b>Plasma Coating – From the Research</b>	
Chief Engineer Celebrates 60 Years of Service	28	Use of Recyclates in Food Contact-Method	
		Development for the Validation	
		of Plasma-Induced Barriers	46



# Cover

The battenfeld-cincinnati group develops, designs and produces customized extruder and complete extrusion lines for companies in a wide range of industries – from the construction industry to water management. The innovative extrusion solutions are used in various applications in the areas of pipe, profile, sheet, board, thermoforming sheet and pelletizing. Established in the 1940s, battenfeld-cincinnati is one of the oldest companies in this sector and has production facilities in Germany, Austria, China and USA. battenfeld-cincinnati is dedicated to research and development in order to continuously offer new and improved solutions for plastics extrusion. Sustainability and energy efficiency are at the center of the innovation strategy. battenfeld-cincinnati is a Davis Standard Company, USA, and stands for quality in plastics extrusion as reliable partner for customers worldwide.

**battenfeld-cincinnati Germany**  
[www.battenfeld-cincinnati.com](http://www.battenfeld-cincinnati.com)



## 18

SIKORA's new LASER PRO sets even higher standards in the field of hose and tube diameter measurement. Designed based on the trusted LASER Series, which has been used in numerous extrusion lines worldwide for several decades, the new series includes additional user advantages

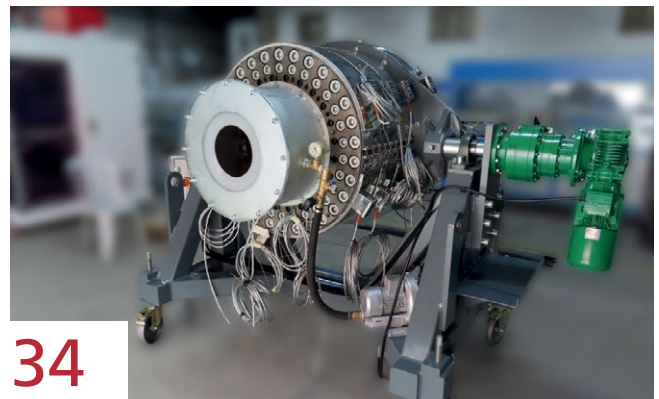

## 34

Why barrier pipes? Because the aim is to protect a medium which is either inside or outside the pipe against permeation of (toxically) substances like gas or liquid. CONEXTRU has developed a flexible Cross Head System for barrier pipes up to 400 mm

Radar technologies can help blow molders maintain high quality standards and minimize material and energy consumption. iNOEX's Warp Gauge sensor and Warp Portable can help offset the skilled-worker shortage and ensure the quality of blow molded parts

For 60 years, H. Schoenberger has been a name synonymous with the manufacture of high-quality premium knives. In the field of plastics, the company focuses not only on products for the recycling industry but also on cutting rotors for strand pelletizer. At the forefront is the unique KRONOS-Max.



## 38

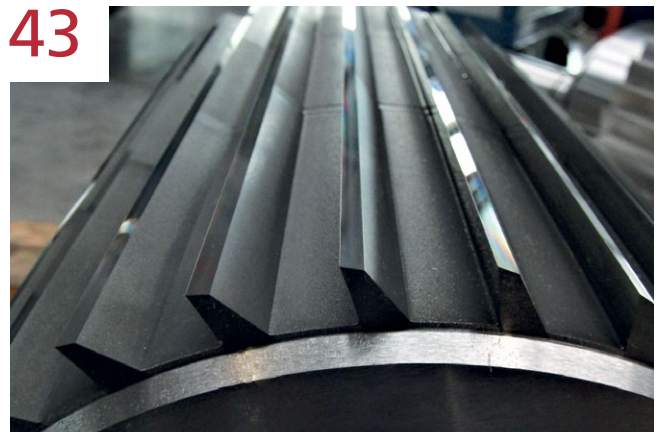

## 43

## Index of Advertisers, companies and fairs referred in this issue

AMAPLAST	14	LEWA	42
battenfeld-cincinnati	Outside Cover	Lindner	23
BHS-Sontheofen	30	Magpet Polymer	36
BIO-FED	27	Messe Düsseldorf	9, 13
CONEXTRU	13, 34	motan	7, 15
Coperion	36	NGR	24
Davis-Standard	19	Nordson Polymer Processing	26
EREMA	22, 37	NORMA	27
Fakuma 2024	8, 11	Orion	25, 32
Farrel Pomini	29	PLASTICS	28, 29, 30, 31, 32, 33
Flender	Outside Back Cover	Reifenhäuser	20
GAIA	26	Schall, P.E.	8
GINDUMAC	12	Schönenberger, H.	43
GREENPLAST	10	SI Group	31
Guill Tool & Engineering	22	Sikora	18, 44
Hellweg Maschinenbau	21	Smart-Extrusion	Inside Back Cover
Herbold Meckesheim	36	SML	16
IKV-Aachen	46	Stein Maschinenbau	Inside Front Cover+3
Innovia	16, 33	Swop 2024	13
iNOEX	38	Uponor	44
ISRA VISION	11	VM Verlag	Inside Back Cover
K 2025	9	Wehrmann	12
KRAIBURG TPE	25	Zumbach	23
Leibinger, Paul	17		

# MEDIA DATA 2025

MAGAZINE · WEBSITE · NEWSLETTER

# EXTRUSION

EXPERT MEDIA ON PLASTICS EXTRUSION





The Extrusion International Magazine is published bimonthly by VM Verlag GmbH. P.O.Box 501812, D- 50879 Cologne, Germany

**EDITOR**

Bettina Jopp-Witt (Editor-in-chief)  
T. +49 221 546 1539  
redaktion@vm-verlag.com

**ADVERTISING SALES**

Martina Lerner  
T.+49 6226 971515  
lerner-media@t-online.de

Jana Bogatzke  
T. +49 1556 614 9190  
j.bogatzke@vm-verlag.com

Bella Eidlin  
T. +49 152 29907895  
b.eidlin@vm-verlag.com

Tanja Bolta  
t.bolta@vm-verlag.com  
+49 15205626122

**ADMINISTRATION**

Alla Kravets  
T. +49 2233 949 8793  
a.kravets@vm-verlag.com

**PRINTING**

maincontor GmbH  
Dr.-Gammert-Str. 13a,  
63906 Erlenbach, Germany  
T.: +49 937294810811  
www.maincontor.de,  
info@frankhohmann.com

**SALES REPRESENTATIVES**

China & Asia  
octavia@ringier.com.hk,  
T. +852-9648-2561  
maggieliu@ringiertrade.com,  
T. +86-13602785446

Tokyo PR Inc. (Japan)  
T. +81 (3) 3273-2731  
extrusion@tokyopr.co.jp

**Reprints, Translation etc**

No part of this publication may be reproduced, stored in a retrieval system, or transmitted, in any form or by any means, electronic, mechanical, photographic, recording or otherwise, without prior permission of the publisher.

[www.smart-extrusion.com](http://www.smart-extrusion.com)



# GRAVICOLOR 310

Gravimetric batch dosing & mixing unit for injection moulding, blow moulding and extrusion processes.

Please visit us:  
Hall B1, Stand 1111  
15th - 19th October 2024



**ZERO LOSS**

[www.motan.com](http://www.motan.com)



#### Fachpack

24 - 26 September 2024  
Nuremberg / Germany  
[www.fachpack.de](http://www.fachpack.de)

#### Solids Dortmund

09 - 10 October 2024  
Dortmund / Germany  
[www.solids-dortmund.de](http://www.solids-dortmund.de)

#### Fakuma 2024

15 - 19 October 2024  
Friedrichshafen / Germany  
[www.fakuma-messe.de](http://www.fakuma-messe.de)

#### Swop – Shanghai World of Packaging

18 - 20 November 2024  
Shanghai / P.R. China  
[www.swop-online.com/en](http://www.swop-online.com/en)

#### Plast Eurasia 2024

04 - 07 December 2024  
Istanbul / Turkey  
[plasteurasia.com](http://plasteurasia.com)

#### ICE Europe 2025

11 - 13 March 2025  
Munich / Germany  
[www.ice-x.com](http://www.ice-x.com)

#### PLASTIMAGEN

11 - 14 March 2025  
Mexico City / Mexico  
[www.plastimagen.com.mx/es](http://www.plastimagen.com.mx/es)

#### CHINAPLAS 2025

15 - 18 April 2025  
Shenzhen / P.R. China  
[www.chinaplasonline.com](http://www.chinaplasonline.com)

#### K 2025

08 - 15 October 2025  
Düsseldorf / Germany  
[www.k-online.de](http://www.k-online.de)

#### interpack 2026

07 - 13 May 2026  
Düsseldorf / Germany  
[www.interpack.de](http://www.interpack.de)

## Materials, Processes, Energy: the Focus is on Efficiency at Fakuma 2024

*The industry will meet in Friedrichshafen for the 29th Fakuma international trade fair for plastics processing from the 15th through the 19th of October, 2024. For many companies, the autumn highlight is one of the most important trade fairs and will once again be a celebration of plastics. Career Friday will take place for the first time this year with the objective of inspiring young people for careers in the plastics industry. The "Fakuma Roundtable" will be held for the second time, addressing this year's topic of "Digitalisation – Top or Flop?"*

■ Efficiency will be a key topic at Fakuma 2024 – on several levels and from a variety of perspectives. Increased efficiency in terms of materials and energy consumption is crucial, as are process efficiency and the efficient operation of production systems, because in light of current shortages of qualified personnel, consistently high levels of quality can only be achieved reliably and efficiently with easy-to-use control systems and digital assistance. As a result of the new Energy Efficiency Act, German plastics processors will be challenged to a much greater extent to realise their full potential. Fakuma exhibitors will provide tools and solutions for the challenges of efficiency, the conservation of resources and sustainability.

### Career Friday for Pupils, Students and Entry-Level Employees

Career Friday for pupils, students and entry-level employees will be a new feature this year in keeping with the motto "Mould Your Dreams, Mould Your Future". To-

gether with the trade fair advisory board, trade fair promoters P. E. Schall are launching this campaign to inform young people about a broad range of career opportunities in the plastics industry. The event will be held as an integral part of the trade fair on the 18th of October, 2024. Career Friday will provide the target group with the unique opportunity of meeting Fakuma's international exhibitors in person at their booths and finding out first-hand about exciting career prospects. The exhibitors will offer young visitors insights into the world of plastics processing, product development and new technologies. In dialogue with industry experts, interested parties will receive exciting background information on plastics processing and insights into work processes. Career Day will reveal practical opportunities for vocational training and career options. Furthermore, the "Mould Your Dreams, Mould Your Future" campaign is a tremendous initiative, because nowhere else do young people and



potential employers come closer together than directly at the trade fair. Collaborations pursued by the exhibitors with partners all over the world provide talented young people with the chance of gaining intercultural experience along their career paths and tackling global challenges as part of a team. And thus the 29th Fakuma invites all pupils, students, teachers, university representatives and young professionals to visit the trade fair highlight free of charge on Career Friday, and to discover the world of plastics processing.

### Discussion about Digitalisation at the Roundtable

This year's Fakuma Roundtable is further highlight which focus on digitalisation in plastics processing at 15th of October. The discussion is entitled "Digitalisation – Top or Flop?", and will examine the ques-

tion of which digital tools really help the plastics industry. Panellists including professor Dr. Braungart, founder and scientific director of BRAUNGART EPEA, Philipp Lehner, chief executive officer of the ALPLA Group, Guido Frohnhaus, director of technology at Arburg, Professor Dr.-Ing. Hans-Josef Endres from the Institute of Plastics and Recycling Technology at Leibniz Universität Hannover and professor Thomas Seul from Schmalkalden University of Applied Sciences will discuss the current level of digitalisation in the industry, as well as what still needs to be done. The discussions are also intended to reveal the extent to which digitalisation can solve the challenges faced by the industry, i.e. sustainability and the shortage of qualified personnel. The Fakuma Roundtable will be moderated by Markus Lüling, editor-in-chief at K-Profi. All interested parties are

invited to attend the discussion – participation is free of charge.

### One of the Most Important Working Trade Fairs

For many companies, Fakuma is one of the world's most important trade fairs. The industry highlight retains its relaxed atmosphere, even with high levels of internationality. Fakuma's typical expert visitors are highly professional, thus making it possible to engage in intensive, top-quality discussions. They value the trade fair's thematic focus on their own needs and requirements. Plastics processors get concrete answers to their questions at the event and find out how they can improve their operations, increase their efficiency and strengthen their business resilience. Fakuma is a genuine working trade fair – pragmatic and highly practical.

► [www.fakuma-messe.de](http://www.fakuma-messe.de)

## Great Interest in K 2025

■ Exhibition space at K 2025 is in high demand the world over. Under the motto "The Power of Plastics! Green – Smart – Responsible" the coming K will focus on the industry's relevant fields of action: Circular Economy, Digitalisation and Social Responsibility.

K 2025 will follow on from a successful event in 2022. After the official registration deadline in late May one thing is certain: all renowned companies in the international plastics and rubber industry will take part in this their leading trade fair held in October next year. Demand for stand space is high and all 18 halls of Düsseldorf Exhibition Centre and the outdoor premises will be fully occupied again.

To Erhard Wienkamp, Managing Director at Messe Düsseldorf, the great interest shown by the industry as a whole confirms the outstanding position of K Düsseldorf: "K 2025 will provide the complete overview of a plastics industry undergoing transformation and again have a plethora of impressive innovations in store. We know that many of our

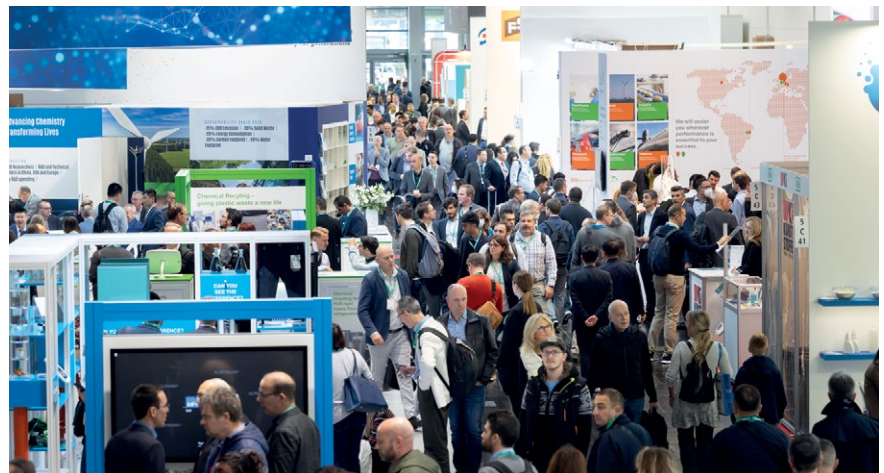

exhibitors are already preparing their product innovations and presentations at full speed. Düsseldorf will once again provide forward-looking impetus for the entire plastics and rubber industry."

More than 3,000 exhibitors will participate in K 2025 from 8 to 15 October and introduce the global expert audience to their ranges in the areas of • Raw materials, auxiliaries, • Semi-finished products, technical components and reinforced plastic parts, • Machinery

and equipment for the plastics and rubber industry.

Especially well represented again will be the suppliers from Germany, Italy, Turkey, Austria, Switzerland and the USA while the number of producers from China, India and Taiwan has increased yet again.

"The Power of Plastics! Green – Smart – Responsible." reads the slogan of K 2025, which is complemented by three core messages "Shaping the Circular Economy", "Embracing Digitalisation" and



“Caring about People”. This places the focus on the three most relevant fields of action for the sector: Circular Economy, Digitalisation and People. The latter involves corporate social responsibility just as much as future career perspectives for young professionals in the plastics and rubber sectors.

K in Düsseldorf is a trend barometer and innovation forum for the

global industry. Every three years the latest developments celebrate their debuts here, innovative and pioneering technologies are presented and international networks established. The exhibitors’ ranges at their stands are complemented by K’s special formats. The special show organised by Plastics Europe Deutschland, will also reflect the three focal themes of K 2025. At

the Science Campus the latest activities and results of university and science organisations will be presented again – here research and business are dovetailed. Organised by the Plastics and Rubber Machinery Association within the German Machinery and Equipment Manufacturers’ Association (VDMA) a large Circular Economy Forum is planned to feature on the outdoor premises where exhibitors demonstrate the pivotal importance of technology for implementing the circular economy in the plastics industry. A Hotspot on the theme of rubber will be the re-designed Rubberstreet under the auspices of the wdk e.V. (Trade Association of the German Rubber Industry) in Hall 6. Here, exhibitors will be showcasing the innovative operational excellence of rubber and thermoplastic elastomers.

➔ [www.k-online.de](http://www.k-online.de)

## GREENPLAST 2025

■ Decarbonization, circular economy, recycling, reuse, and micro- and nanoplastics are just some of the topics of relevance in the plastics industry. They are increasingly featured in the news and have a significant impact on public opinion. It is thus indispensable to keep up to date on market trends and innovations in materials, products, processes, and production technology because real changes are underway and we have to stay abreast of them.

Greenplast debuted in 2022 with the precise goal of embracing these issues that are now fundamental to the entire plastics and rubber industry. It is the first Italian exhibition/convention for the sector, focusing on sustainability and energy efficiency, organized by Amaplast (Italian association of machinery and moulds manufacturers for plastics and rubber) through its operating company Promaplast, which is also the organizer of Plast.

Following up on the successful first edition – which was populated by 170 exhibitors (80% Italian, 20% from abroad) occupying 6,000 square metres of net exhibition space and drawing in over 20,000 visitors from 55 countries –, applications are now being accepted to the second edition, which will take place from 27 to 30 May 2025 in Milan.

The collaborative relationship among all the players in the supply chain will accelerate the transition to a circular economy of plastics, reductions in harmful emissions, and the promotion of a more sustainable use of the material, which is indispensable for many areas of



the economy and able to play a fundamental role in achieving sustainability and maintaining the competitiveness of the Italian industrial system. The compound annual growth rate (CAGR) for the various applications of recycled materials shows very positive dynamics and potentials for development in all sectors.

The second edition of Greenplast will again be part of The Innovation Alliance: four fairs – Ipack-Ima, Print4All, Intralogistica Italia, and Greenplast – taking place simultaneously, occupying nearly the entire Fiera Milano facility in Rho Pero with visitors having full access to all halls.

This initiative is designed to promote and facilitate opportunities for contact, networking, and development, laying out the full panorama of the industry to visitors and leveraging the complementary nature of the four sectors: plastics and rubber; packaging and packing; printing and converting; and logistics.

➔ [www.greenplast.org](http://www.greenplast.org)

## Inline Inspection of Polarizer Films

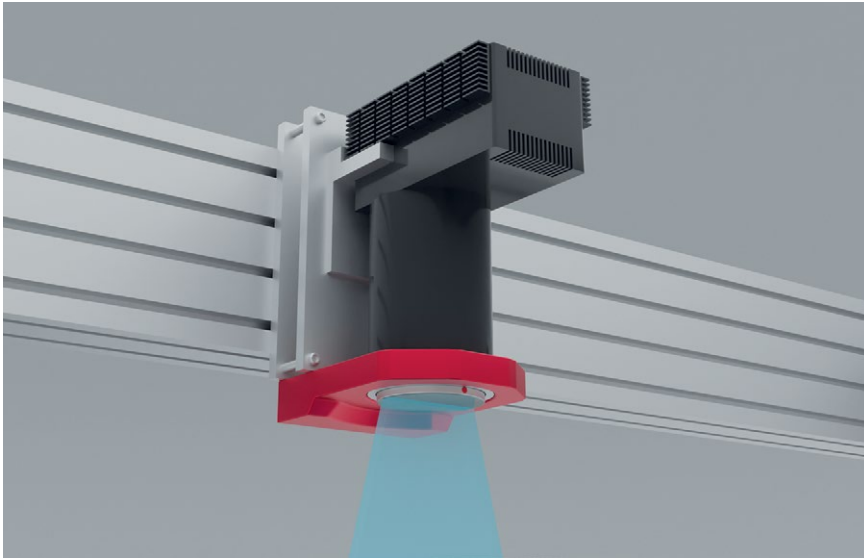

■ ISRA VISION has further enhanced its optical inline inspection system for polarization films. It has equipped it with a new sensor system that enables even better detection of typical defects such as scratches, Harley Bear, and perforations. Thanks to a special additional lens, the polarization angle of the camera can be automatically changed. Pre-configured product-specific profiles can be transmitted online to the camera. There is no need to halt production to adjust. This not only helps to further optimize the inspection performance and the quality of the end product but also saves time and costs.

With SMASH, ISRA VISION offers an automatic surface inspection solution for the production of optical films such as prism films, polarizer films, protective films, and window films. Thanks to high-resolution line-scan cameras and state-of-the-art lighting technology, the system can recognize even the tiniest defects, even at line speeds of up to 150 m/min. The trainable defect classifier QuickTeach helps to simplify and speed up system start-up. A comprehensive set of tools for data recording, analysis, and reporting functions rounds off the package.

The polarizing filter ISRA VISION uses for the inline inspection of polarizer films allows automatic adjustment of the polarizing angle in

*ISRA VISION has further enhanced its optical inline inspection system for polarization films and equipped it with a new sensor system that enables even better detection of typical defects such as scratches, Harley Bear, and perforations*

the event of phase changes in the film. It sets the polarizer to full-light extinction or other predefined settings without the need to stop production. Because the camera thus always receives an optimum input signal, defects can be recognized even more efficiently and reliably. This helps to optimize product output and product quality further. Product-specific settings can be pre-configured as recipes and transmitted online to the camera during operation. Compared with the manual setting of the polarization angle, the automatic adjustment ensures higher precision and also saves both time and money.

By using this new polarizing filter, the waste generated during production start-up can typically be reduced by up to 1,000 m<sup>2</sup> per 8-hour shift, depending on the roll width and line speed. This not only increases the amount of saleable products but also protects resources by reducing material consumption and production waste.

ISRA VISION GmbH

www.isravision.com

<https://go.isravision.com/optical-film>



**29<sup>th</sup> Fakuma**  
International trade fair  
for plastics processing

 **15.-19. Oct. 2024**

 **Friedrichshafen**

**digital**  
**meets**  
**circular**  
**economy**



**“ Digitalisation - top or flop? ”**  
 **15.10.2024**  **4.00 p.m.**



**START UP AREA**

 **EXHIBITOR-FORUM**  **SCHALL**

 **Secure your free of charge ticket:**

Registration page:  
[www.schall-registrierung.de](http://www.schall-registrierung.de)  
Ticket code: YDFVQ-W15WF



 **fakuma-messe.com**

 **#fakuma2024**

**Organizer:**

**P. E. SCHALL GmbH & Co. KG**

 **+49 (0) 7025 9206-0**

 **fakuma@schall-messen.de**

## Acquisition

■ The GINDUMAC Group, a leading B2B transaction platform for machine trading in Europe, retroactively acquires the family-owned company Wehrmann GmbH & Co. KG from Barntrup/Germany as of January 1, 2024. Wehrmann has a tradition of over 80 years in the woodworking industry and has consistently positioned itself as a global B2B platform for woodworking machines, special machines, and services since 2010.

With this acquisition, GINDUMAC is actively advancing its platform strategy by expanding its range and business model in the field of woodworking machines. For the family-owned company Wehrmann, the takeover ensures a secure succession plan and provides a long-term future perspective for the employees at the Barntrup site.

During the takeover phase, Wehrmann and GINDUMAC will focus on independence, continuity, and the digital platform strategy. Wehrmann will continue to operate as an independent legal entity and brand. The proven range of services will be maintained, and existing business relationships with customers, suppliers, and partners will be strategically strengthened. At the same time, the already successful platform strategy will be expanded, and a closer connection with GINDUMAC's B2B portals will be a focus.

The current managing director of Wehrmann GmbH & Co. KG, Agne

*During the takeover phase, Wehrmann and GINDUMAC will focus on independence, continuity, and the digital platform strategy*



*The GINDUMAC x Wehrmann Management Team: From left to right, Daniel Kaiser (Co-CEO, GINDUMAC Group), Agne Odenram (Managing Director, Wehrmann), and Benedikt Ruf (Co-CEO, GINDUMAC Group)*

Odenram, will continue to lead the operational business in the future. Daniel Kaiser and Benedikt Ruf, Co-CEOs of the GINDUMAC Group, will expand the management team and primarily focus on expanding the B2B platform business for the woodworking industry.

Agne Odenram, Managing Director of Wehrmann GmbH & Co. KG, on the new future direction: "For me, it was particularly important to find a new owner with high innovative power for the enormous potential of our traditional company Wehrmann. With GINDUMAC, we have found the perfect and extremely digital platform partner to take the necessary steps in digitization and modernization to make Wehrmann future-proof. With a clear commitment to the Barntrup location and the introduction of international platform expertise, the takeover by GINDUMAC creates a

strong foundation to grow as a progressive employer from the region."

Daniel Kaiser, Co-CEO of GINDUMAC, emphasizes the strategic importance of the acquisition: "The acquisition of Wehrmann is a decisive milestone in our growth strategy. This takeover enables us to efficiently tap into the market segment of woodworking machines. At the same time, we can strategically diversify our service offerings within the GINDUMAC Group through storage, maintenance, and assembly services. This brings our B2B machinery platform to a new dimension."

Benedikt Ruf, Co-CEO of the GINDUMAC Group, on the platform strategy: "We are convinced that combining our platform expertise with Wehrmann's longstanding experience in the woodworking machinery sector will unleash significant synergies. We will leverage the strong business partnerships with Wehrmann's customers, suppliers, and partners and generate new growth with the global GINDUMAC network. GINDUMAC has grown significantly organically since 2020. Now we are undertaking our first acquisition to establish a new segment in our global platform."

GINDUMAC

► [www.gindumac.com](http://www.gindumac.com)

Wehrmann

► [www.wehrmann-maschinen.de](http://www.wehrmann-maschinen.de)



## Shanghai World of Packaging (swop) 2024

■ As one of the largest trade fairs for the processing & packaging industry in Asia, Shanghai World of Packaging (swop) each year attracts tens of thousands of visiting professionals from the sectors food and beverage packagings, pharmaceuticals, cosmetics and consumer goods.

More than 30,000 visitors attended swop 2023, among them well-known brands – in 2024, the halls are said to be of a similar calibre. The reason is that for these top brands, the trade fair is an important meeting opportunity within the booming Chinese packaging market. This is where all relevant market segments and trends come together. This year as well, national and international exhibitors, among them from China, Germany, Japan and the United Kingdom, are expected from 18 to 20 November on the approx. 65,000 square meters of exhibition space at the Shanghai New International Expo Center. The swop trade fair, which is part of the portfolio of inter-pack alliance, covers all sectors of the packaging industry, from machines and materials to logistics and recycling.

88 percent of the visitors at swop 2023 were decision makers or influencers, and for the current edition, the hosts of Messe Düsseldorf (Shanghai) Co., Ltd. and Ad-sale Exhibition Services Ltd. are hoping that high-ranking experts from the industry will participate in order to purposefully strengthen new opportunities for networking and business. In this context, the cooperation of swop with important key players in the Chinese market is of central importance. For example, the new cooperation with the “Chinese Institute of Food Science and Technology (CIFST)” will attract numerous professionals from the food industry to the trade fair.

The new partnership with CIFST allows swop to purposefully extend its influence to exclusive purchasers within the Chinese food industry. The cooperation marks the debut of the “Food Processing and Intelligent Manufacturing Zone” at the trade fair, which specialises in innovative processing technologies and packaging solutions for food producers. The forum will cover a number of current topics, among them artificial intel-

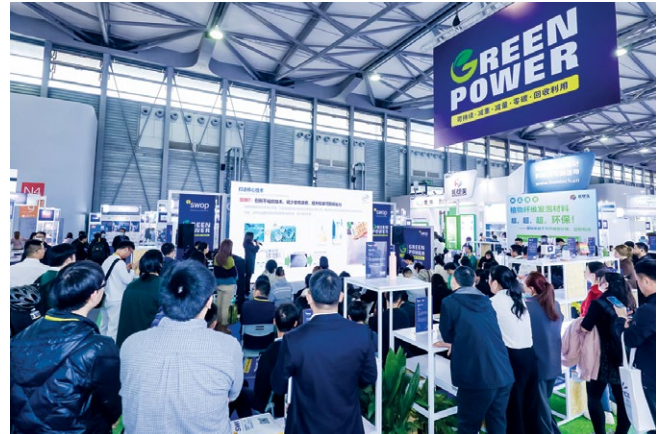

ligence, food big data, image analysis of food, machine learning, intelligent manufacture, nutrition and safety as well as quality control. Around 300 key players and managers from the industry are expected.

### Exhibitors can still register

swop offers the opportunity to meet influential leaders in the industry, gain insights into the up-and-coming-Asian market and enter into strategic business partnerships. Interested exhibitors can still register for swop – one of the easiest and most comfortable ways is to participate in the German or International Pavilion with an all-inclusive package.

Participation by international exhibitors and visitors will be further facilitated by China's decision to implement a unilateral visa-free policy for ordinary passport holders from 15 countries, including Germany, France, Italy, the Netherlands, Spain, Switzerland, Austria and Poland, to travel to China for 15 days without a visa, including for business visits.

Messe Düsseldorf GmbH

➔ [www.swop-online.com/en/](http://www.swop-online.com/en/)



**CONEXTRU is celebrating 15 years of successful presence in the tough competitive machinery market.**

CONEXTRU offers a wide product line of extruders, mono- and multi-layer pipeheads and cross heads as well as vacuum and spray cooling tanks. Additionally Conextru supports machine manufacturer with technology.

[www.conextru.eu](http://www.conextru.eu)

 **HIGH LEVEL OF TECHNOLOGY AND KNOWLEDGE**

 **INDIVIDUAL DESIGN**

 **40 YEARS EXPERIENCE IN EXTRUSION DESIGN**

 **EFFICIENT COMMUNICATION WITH LOW ADMINISTRATION**

## AMAPLAST ASSEMBLY – *The Federation project takes off*

*On 6 June 2024, Villa Arconati hosted the annual Members Assembly of Amaplast – the national trade association affiliated with Confindustria representing approximately 170 manufacturers of machinery, equipment, and moulds for plastics and rubber.*

■ On this occasion, the association's leadership was renewed with the election of new members:

- General Council, with the election of Luna Artico (FRIUL FILIERE), Alessandro Balzanelli (F.B. BALZANELLI), Michele Bandera (COSTRUZIONI MECCANICHE LUGI BANDERA), Alessandra Bosco (INGLASS), Gianfranco Cattapan (PLASTIC SYSTEMS), Maria Grazia Colombo (BFM), Giovanna Franceschetti (GEFRAN), Gianni Luoni (ELBA), Fabiola Plebani (MAST) for the 2024-2026 term

- Board of Arbitrators, with the election of Erica Canaia (FIMIC), Carlo Cominelli (ITIB MACHINERY), Andrea Fantozzi (MOSS), Valeria Giacomoni (SICA), Aldo Zaffaroni (ZAFFARONI) for the 2024-2028 term

- Board of Auditors, with the election of Gianni Cazzulo (chartered accountant), Claudia Cribiù (CRIZAF), Roberta Rivi (RIVI MAGNETICS) for the 2024-2028 term.

During his speech, President Massimo Margaglione made remarks about the performance of the Italian industry of machinery, equipment, and moulds for plastics and rubber. Drawing on data from the association's research centre, he observed that, despite a challenging global environment, the sector had seen growth of 2.8% in 2023. Although this increase was less pronounced than in the previous two years, it brought the value of production to a record 4.8 billion euros. Exports remain the main driving force with an 11% increase compared to 2022, solidifying Italy's position as the world's third-largest exporter, following China and Germany.

The assembly endorsed their commitment to the federative project that led to the founding of Confindustria Machinery Federation, for ceramics, wood, plas-

tics and rubber, and packing and packaging. Alongside Amaplast, this federation includes:

- Acimac - Association of Italian Manufactures of Machinery and Equipment for Ceramics

- Acimall - Italian Woodworking Technology Association

- Ucima - Italian Packaging Machinery Manufacturers' Association.

The goal is to pool the skills and experiences of each association to expand and further improve the quality of the services offered to member companies.

The newly formed Federation represents over 1,300 companies, with a workforce approaching 70,000 employees, and a total revenue surpassing 19 billion euros.

Vice Presidents Gabriele Caccia and Barbara Ulcelli recapped the initiatives undertaken by Amaplast over the past year, with particular emphasis on the PLAST 2023 fair. They also provided details regarding upcoming plans, highlighting the preparations for GREENPLAST 2025 (Milan, 27-30 May 2025, once again as part of The Innovation Alliance).

### Sector Overview

According to the analyses conducted by the MECS-Amaplast research centre, the Italian industry for machinery, equipment, and plastics and rubber moulds closed 2023 with growth of 2.8% despite the challenging global context marked by conflicts, inflationary pressures, and high interest rates. This increase, though more modest compared to that of the preceding two years, propelled production to an unprecedented record of 4.8 billion euros.

Despite economic and commercial uncertainties across various geographical regions, which worsened in the last quarter of

the year, the performance of the sector remained positive, driven primarily by exports. Said exports saw a remarkable growth of nearly eleven percentage points compared to 2022. Italian manufacturers of plastic and rubber machinery experienced particularly strong sales in key markets such as the European Union (+9% over 2022), North America (+18%), and Asia (+8%, with the Middle East up by 50% and the Far East down by 1%). Though with smaller shares, South America also registered a 23% increase.

In the top ten export markets for Italian manufacturers, notably positive results have been observed in France, Spain, and Romania, as well as in Mexico and Turkey. Only Poland and India showed declines, despite both having enjoyed very favourable trends in previous periods.

The comparison with Germany and China – Italy's two main competitors – reveals that their respective exports of machinery for plastics and rubber registered increases of 7.5% and 12.9% compared to 2022. Even when looking at the past decade, Italy's performance lies somewhere between that of its two primary competitors, totalling an average of 3.5%, compared to Germany's 2.9% and China's 9.0%.

However, it is undeniable that the commercial pressure from China has been steadily intensifying over the past decade across all major geographical regions. At CHINAPLAST, held from 23 to 26 April, it was all the more evident that Chinese technology is advancing at a quick pace. This serves as an impetus for Italy to leverage its unique ability to develop increasingly innovative, flexible, and naturally performing solutions – also in terms of energy efficiency.

The 2023 financial report for Amaplast member companies is in line with that of the entire sector: the association noted a revenue growth of 2.4% – not as strong as the one registered over the previous two years, but significant still. Additionally, there was a modest increase (1.1%) in the workforce.

While core-machinery (primary processing equipment) production has registered a slowdown, the

production of auxiliary and downstream equipment, components, and moulds has continued to show a significant increase.

The trend among the sector – mirroring that of the industry generally and the capital goods sector – cooled down over the final months of 2023 but more encouraging signs were observed in April and May. Nevertheless, forecasts for the upcoming months are

rather cautious: many companies will find it challenging to achieve further growth, and a period of stabilization and transition is to be expected. Domestic demand, in particular, may remain weak due to uncertainties surrounding the effective implementation of Transizione 5.0 measures.

► [www.amaplast.org/it/](http://www.amaplast.org/it/)

## Precision Gravimetric Dosing & Mixing

■ The motan group introduces its first gain-in-weight range of dosing and mixing units featuring dual dosing methods under the swift brand.

The motan group is proud to unveil the sBLEND G, a groundbreaking dosing & mixing unit within the swift brand, designed to bridge the gap in gravimetric dosing & mixing. This innovative unit, combining cost-efficiency with advanced technology, caters to the needs of plastics processors looking for a standardised solution for their dosing and mixing requirements.

The sBLEND G employs two distinct dosing methods: vertical slide valves for main components and screw feeders for precise additive dosing. This dual approach ensures unparalleled accuracy and flexibility. The bowl-shaped mixing chamber, equipped with an optimized agitator, guarantees homogeneous mixing in a dead-spot-free zone, monitored by the advanced sBLEND microprocessor control system. This allows for reducing additive quantities to the lower tolerance limit, ensuring cost savings without compromising quality.

The sBLEND G unit supports gain-in-weight dosing and mixing for up to four materials, available in three sizes for throughput rates of 50, 130, and 300 kg per hour. The standard configuration includes two vertical slides, controlled by pneumatic cylinders, for precise dosing of main components like virgin

material or regrind. For finer dosing and greater accuracy, optional screw dosing modules can be added. These modules prevent material trickle and avoid overdosing expensive additives. They are available in various sizes and can be removed and exchanged without the need for tools, offering flexible configuration to meet specific application requirements.

Designed for convenience, the sBLEND G features a quick-change system for dosing modules and quick-release screws, simplifying cleaning and material changes. The weigh bin and mixing chamber can be easily removed without tools. All contact parts are made of stainless steel, ensuring contamination-free operation and easy cleaning. The brushless, swivel-mounted dosing motors with integrated motor management are maintenance-free and easily removable, guaranteeing reliable continuous operation.

The bowl-shaped mixing chamber design ensures a homogenous mix and consistent material discharge. When mounted on the processing machine inlet, the material path from the mixing chamber to the processing screw is minimized, preventing unwanted material segregation. Alternatively, the unit can be mounted on a frame and placed on the floor or serve as a central station for multiple processing machines.

The sBLEND G, like all swift units, features a modern microprocessor

control with an innovative, open network architecture based on Ethernet. This allows for both direct operation via a 7-inch colour touchscreen and remote control. The sBLEND controller monitors and displays throughput and supports weight calibration, automatically calculating material addition speeds.



*sBLEND G – Gravimetric batch blender with high accuracy (motan Group)*

motan holding gmbh  
► [www.motan-group.com](http://www.motan-group.com)

## Dedicated Low Density Film for Ice Cream Flow Wrap Packaging Launched

■ Innovia Films, a material science pioneer and major producer of BOPP films, has announced the launch of a white ultra low density film that was specifically engineered to be a good fit for ice cream flow wrap packaging.

"Nothing screams summer more than ice cream and we are proud to be able to offer our new VL40 white cavitated film that is an excellent partner for one of our favourite summer treats. A typical way to package ice cream is to use high-speed flow wrap packaging that preserves the quality of the product until consumption", explains Alasdair McEwen, who heads up the European Packaging Division of Innovia.

The new film grade was developed and successfully trialled and launched by the science material experts at their Innovia Films site in Płock, Poland.

"Our film is a high-gloss white coextruded OPP film with a very wide heat seal range. We made some significant changes to our



extrusion lines to be able to deliver this specific film grade that is ideal for ice cream sandwiches and popsicles. The team did a great job in a very short time", comments Piotr Piasny, General Manager at Innovia Films in Płock. Amongst other features it offers a very high puncture resistance which is important to preserve the valuable product and prevent food waste. The printability of the product means you can achieve a superior graphic appeal, and the film provides an easy-to-open package".

The films are largely unaffected by climatic conditions but should not be stored at temperatures above 104°F (40°C). Under suitable storage conditions, the film can be stored for a period of 6 months without any risk of deterioration.

Innovia Films Ltd,  
[www.innoviafilms.com](http://www.innoviafilms.com)

## 2-Meter Stretch Wrap Film Line – Fully Revised and Extended

■ The 2-meter EcoCompact® II features a number of technical innovations, packed in a fresh new design. Like its predecessor, it combines a compact line set-up with excellent components and maximum flexibility, while maintaining an affordable price.

At K 2010 trade fair, SML introduced the EcoCompact®. A standardised 4 up (2,000 mm) wide stretch film line with premium components, an extremely compact design and a reasonable price that revolutionised the market. "The EcoCompact® was a hot seller right from the go. Now, 14 years later, it is time for a total refinement," Thomas Rauscher, Product Manager at SML states.

To cover almost every potential demand in production, the EcoCompact® II comes in four pre-configured versions, ranging from a minimum of four extruders to a



maximum of seven extruders. Beside 5-layers and 7-layers versions, the line can be optionally fitted with Nanolayer-Technology. SML's well-known Ø 1,600 mm chill roll unit and an e-container are now included as a standard.

*New EcoCompact II stretch film line with double turret winder W4000-WS (Credit: SML/KHP)*

The winder is a key part of any stretch film line. In the EcoCompact® II, customers can choose



from three different versions of SML's powerful winder W4000: A 2-shaft version, the well-known 4-shaft type and, last but not least, a double turret winder with a total of 8-shafts. "The advantage of the 8-shaft winder is the ability to use 2" winding cores for hand rolls. Generally, this type of winder is capable of running at very high speeds. This boosts the perfor-

mance of the EcoCompact® II to the next level," Thomas Rauscher says.

As a standard, the EcoCompact® II comes with a Cloeren Reflex die, the benchmark technology for ultra-fast and hands-free die lip control. It can be upgraded with an automatic die mapping system.

Also available are cut resistance rollers, coreless winding, modified

edges and much more. "Thanks to the comprehensive technical possibilities of the 2-meter-EcoCompact® II, flexibility in stretch film production is guaranteed," Thomas Rauscher from SML concludes with pride.

SML Maschinengesellschaft mbH  
 ➔ [www.sml.at](http://www.sml.at)

## "German Innovation Award"

*The German Design Council has honored LEIBINGER's innovative, high-performance industrial printer, IQJET, with the Gold German Innovation Award on May 14th in Berlin. Additionally, the marking system specialist was named Innovator of the Year 2024.*

■ The interdisciplinary expert jury of the German Design Council awarded IQJET in the category "Excellence in Business to Business: Machines & Engineering" with the Gold German Innovation Award. The award is based on criteria such as sustainability, quality, and economic efficiency for outstanding products, projects, and pioneering achievements. About 300 guests from politics, business, and media attended the festive event.

IQJET, for instance, prints texts, logos, and codes on a variety of surfaces such as metal, plastic, glass, and paper. The device guarantees high performance, exceptional print quality, and efficiency with reliable continuous operation and no need for cleaning. Users benefit from the unique "Plug&Print" performance, easy operation, and five years of maintenance-free operation. Compared to conventional printers, IQJET reduces operating costs by up to 30 percent. Furthermore, companies optimize their ecological footprint through the low consumption of energy, ink, and solvents.

Christina Leibinger, CEO of LEIBINGER, and COO Jan van het Reve personally accepted the award. Leibinger summarizes, "We have set a goal to continuously optimize industrial CIJ printing and take a leading role as a provider of innovative coding & marking technol-



ogy. We are proud that our innovative strength has also impressed the jury." Van het Reve adds, "Our developments are always focused on benefiting the

customer, meaning that with the LEIBINGER printers we aim to make a significant contribution to operating cost optimization, sustainability, and efficiency in manufacturing and packaging lines worldwide."

The nomination committee also recognized LEIBINGER as Innovator of the Year 2024. Renowned business, science, and media experts consider LEIBINGER to be the pioneer in its field. The award is the largest audience award in Ger-

*Christina Leibinger, CEO at LEIBINGER, and Jan van het Reve, COO, accepting the German Innovation Award in Berlin*

man business, honoring companies of every size and industry as well as innovative ideas from all areas of business. Over 70,000 entrepreneurs, CEOs, and other business enthusiasts also choose the winners of the audience awards online in various categories.

Paul Leibinger GmbH & Co. KG  
 ➔ [www.leibinger-group.com](http://www.leibinger-group.com)

## Smart Length Measurement of Hoses and Tubes

■ The LM SMART stands for smart length measurement, and it expands SIKORA's product range with an innovative length measuring device. The system measures lengths without contact and with extraordinary accuracy of 0.05 %. Compared to conventional contact-based solutions, there is no slippage or wear. Once the device has been configured, no further calibration is required. The LM SMART measures accurately and reliably over time.

Length measuring devices are used to ensure that the required

hose or tube length is accurate. Short or excess length leads to yield losses. If the production length is reduced by just 0.1 %, the LM SMART length measuring device pays for itself in just a few months.

The LM SMART is based on the market-proven laser doppler measuring method and therefore functions largely independent of the color, surface quality and diameter of the product. Two laser beams are used to direct light onto the passing product surface. The beams overlap and create a stripe pattern on the object, from which the speed and thus the product length traveled over time is precisely determined.

The LM SMART offers precise length measurement and ensures



The LM SMART complements SIKORA's product range with a smart length measuring device

The measured values of the LM SMART can be displayed on the ECOCONTROL or directly on the system control unit

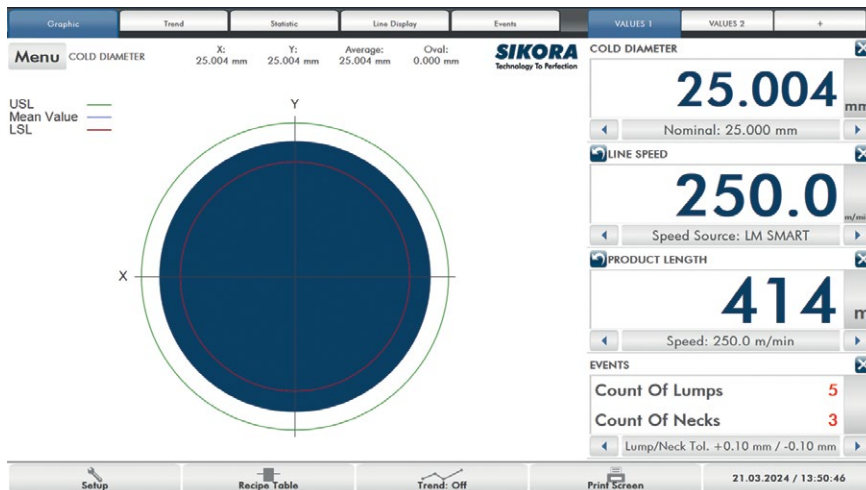

that the required product length is maintained. Thanks to its very compact design, this device can be easily integrated into existing lines. No slippage, no maintenance and only a single calibration. This impressive system ensures smooth, continuous measurement independent of the material, which allows for use on many different products. The long service life also ensures maximum availability of the LM SMART.

## New Standards in Diameter Measurement

SIKORA's new LASER PRO sets even higher standards in the field of hose and tube diameter measurement. Designed based on the trusted LASER Series, which has been used in numerous extrusion lines worldwide for several decades, the new series includes additional user advantages. The LASER PRO comprises three innovative models for product dimensions from 0.1 to 51 mm.

The diffraction analysis in combination with pulse-controlled laser diodes results in an impressive 500,000 measuring points per second per measuring axis in the entire measuring field. This results in 5,000 accurately measured values

per second per measuring axis. This ensures that the values supplied are both accurate and repeatable.

Thanks to the extremely short exposure time of less than 1/1,000,000 seconds, the individual precisely measured values per second per axis are captured with maximum image sharpness. This ensures absolute measuring accuracy, even at high line speeds with product vibrations. Each individually measured value achieves an extraordinarily high single value accuracy.

The non-contact measuring technology of the LASER PRO works entirely without moving parts and is therefore maintenance and wear-



With the LASER PRO, SIKORA launches a device series on the market that measures the diameter of hoses and tubes with the highest measuring accuracy

free. A single calibration before delivery is sufficient to guarantee precision for the lifetime of the device. The availability of the laser measuring heads is 99.8 %.

The LASER PRO offers the option of FFT analysis to detect periodically recurring variations in product parameters. This is an important tool for producing high-quality hoses and tubes and detecting irregularities during extrusion.

The measuring heads of the LASER PRO family provide the ultimate functionality with their compact and slim design. The optical components are located in protected areas. The diffraction analysis detects unavoidable, gradually occurring contamination in real time and reports it. All

*The measuring values are clearly visualized on the ECOCONTROL*

models are designed to be open at the bottom so that neither water nor dirt can fall into the measuring head. The swiveling measuring head concept allows the device to be swiveled out of the working area if required.

The measured values of the LASER PRO are displayed on the ECOCONTROL. Trend data, statistical functions and FFT analyses can also be viewed. The SET POINT control module can be used to control the diameter to the setpoint or minimum value. Using the new LASER PRO ensures the highest product quality, optimizes production and saves costs at the same time.



SIKORA AG  
www.sikora.net

## Operation Clean Sweep Certification Achieved

■ Davis-Standard announced that it has achieved Operation Clean Sweep (OCS) certification, becoming the first OEM in its field to earn this distinction. This certification demonstrates the company's commitment to preventing plastic pellet (resin) loss and contributing to a cleaner environment, setting a new benchmark for environmental sustainability in the plastics industry.

OCS is an international program designed to help plastics industry companies implement good housekeeping and pellet containment practices. By achieving OCS certification, Davis-Standard joins a growing list of companies committed to reducing plastic pollution in waterways and communities.

"Our facilities in Fulton, NY, and Pawcatuck, CT, are blessed with natural beauty and proximity to vital waterways and the ocean," said Giovanni Spitale, CEO of Davis-Standard. "This underscores our responsibility to protect these resources and is why Operation Clean Sweep certification is so important to us."

"Environmental stewardship is deeply ingrained in our company



culture at Davis-Standard," said Dan Guthrie, Chief Operating Officer & President of Film, Sheet, and Core Auxiliaries at Davis-Standard. "Achieving Operation Clean Sweep certification reinforces our dedication to responsible manufacturing practices and our commitment to minimizing our environmental footprint."

This OCS achievement builds upon Davis-Standard's legacy of environmental responsibility and its 2025 sustainability commitments. The company's North American facilities

are now powered by carbon-free electricity, and its Maillefer division received a Silver EcoVadis rating for its sustainability efforts in Finland. Moreover, numerous Davis-Standard facilities maintain ISO 14001 certification for their environmental management systems, with only one remaining to achieve the certification.

► <https://davis-standard.com/sustainability/> and: <https://opcleansweep.org/>

## 18 Micrometer Thin MDO-PE Film Launched

■ Reifenhäuser Blown Film has produced the world's first MDO-PE film just 18 micrometers thick which meets or exceeds all previous market standards in terms of mechanical properties, appearance, and further processing. The film has been produced on Reifenhäuser EVO blown film lines using the patented EVO Ultra Stretch MDO technology and has been developed and tested for practical suitability in collaboration with raw material manufacturer LG Chem and printing specialist BOBST. The new 18-micron film reduces the amount of material used by around 25 percent compared to previous film thicknesses of 25 microns. This makes the production of fully recyclable mono-material structures significantly more economical.

Christoph Lettowsky, Senior Product Manager at Reifenhäuser Blown Film, explains: "Machine builders and manufacturers have been pursuing the same goal for some time: not to use more material in fully recyclable All-PE solutions than in conventional PET-PE laminates. Technically, this is achieved due to the different densities of PET film and MDO-PE film by replacing the 12  $\mu\text{m}$  PET film with a 16 to 17  $\mu\text{m}$  MDO-PE film. With the reduction to 18  $\mu\text{m}$ , we have taken a significant step in this direction – with further downgauging potential for the future."

This leap in development was made possible by the combination of MDO Ultra Stretch technology with suitable raw materials. Thanks to the patented position of the Ultra Stretch unit directly in the system's haul-off, the film is stretched from the first heat. This makes the process particularly reliable: Reifenhäuser has produced the 18-micron MDO-PE film stably and reproducibly over many hours in the test runs.

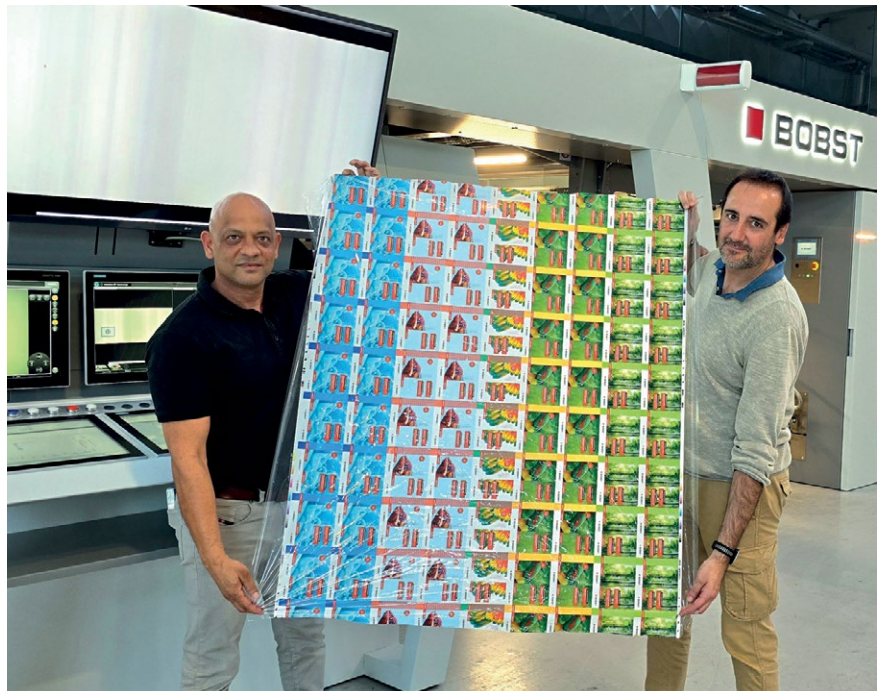

*Davide Rossello, Head of Competence Center and Process Manager Gravure at BOBST (right) and Mohamed Timol, Reifenhäuser expert for MDO processes (left) present the printed and world's first 18 micrometer thin MDO-PE film (Picture: Reifenhäuser)*

Mechanical and optical properties reach or exceed market standard. Despite the low film thickness, producers do not have to make any compromises when it comes to optical and mechanical properties. With a modulus of elasticity MD exceeding 1,400 MPa and a modulus of elasticity TD exceeding 1,100 MPa, the 18-micron MDO-PE film achieves the current market standard for stretched PE films. With a haze of less than 5 percent, the 18-micron MDO-PE film performs even better in terms of optical properties than the market standard, which is 6 to 7 percent.

The 18-micron MDO-PE film also performed excellently in the converting process and exceeded all expectations of printing specialist

BOBST. Davide Rossello, Head of Competence Center and Process Manager Gravure at BOBST says: "The way this extra-thin 18-micron MDO-PE blown film behaves on our printing machines is unique on the market. We have printed the film at high speeds of up to 500 m/min with excellent results in terms of printing quality and register performances. But even more impressively, we were able to demonstrate the quality of our machine when printing in the BOBST oneECG process, achieving excellent print results at 300 m/min (and above)."

Reifenhäuser Group

➔ [www.reifenhäuser.com/en/lines-components/mdo-pe-downgauging](http://www.reifenhäuser.com/en/lines-components/mdo-pe-downgauging)

## Servomotor-Driven Edge Trimming System for Sheet and Film Extrusion

■ Hellweg Maschinenbau's new, individually controllable R 200/20 Servo edge trimming system brings flexibility to the shredding of extrusion edge strips. Touchscreen control enables processors to adapt this step to production conditions and so optimize it for the specific application. Jointly developed with BREYER Extrusion, this new machine complements the extensive range of systems, also known as guillotines or chippers, from this global manufacturer of digitally controlled shredding machines for effective, energy-saving plastics recycling.

Designed for a working width of 200 mm and cutting thickness of up to 20 mm, the R 200/20 Servo continuously pre-shreds one or two edge strips from film or sheet production. A downstream granulator then processes the resulting chips, which are several centimeters in size, into regrind or flakes in the millimeter range as required. These can then be fed straight back into the recycling loop.

Thanks to a servo geared motor, cutting cycle times can be freely set using the associated touchscreen display. As a result, the cutting frequency of the R 200/20 Servo and thus also the length of the edge strip chips can be selected at a constant cutting speed and so optimized for the output of the respective extrusion system and for input to the downstream granulators. Numerous, short chips relieve the load on lower power granulators, while the longer pieces possible when using powerful granulators relieve the load on the chipper. In both cases, electronically controlled edge trimming cuts down on wear and energy consumption. In addition, the high chopping speed permitted by the servomotor results in a smoother process because the permanently advancing film web only runs over the stationary blade for a very short time. This minimizes any counter-thrust and associated lifting of the entire edge strip.

Extrusion requires uninterrupted operation, and this is exactly what



*The touchscreen on Hellweg's R 200/20 edge trimming system, which is equipped with a servo geared motor, allows cycle times to be freely set. This means that the size and number of individual chips can be optimized for further processing independently of extrusion system output (© Hellweg Maschinenbau)*

the R 200/20 Servo is designed for, just like all of Hellweg's other granulator systems. Users can be confident that these granulators with their unsurpassed endurance and minimal maintenance requirements will not be the cause of downtime. The durable special guides and the hardened, low-wear blade support and eccentric roller are further factors backing up this confidence.

As a manufacturer of granulators for any plastics application, Hellweg is expanding its portfolio in step with changing customer requirements. In addition to edge trimming systems, this portfolio ranges from small machine-side granulators for sprues up to high-performance systems for solid parts, film and sheet with a throughput of five metric tons per hour and above. The digital Smart Control System, featured by all the granulators, captures parameters such as power consumption, motor speed and bearing temperatures, as well as blade, screen and V belt status. By continuously opti-

mizing the ratio of engine load to throughput, it ensures particularly economical operation with minimal operator effort.

For example, the MDSi 340/150 Smart Control machine-side granulator, the most powerful model in the series with drive powers from 1.5 kW to 4 kW, achieves granulation outputs of 10 kg/h to 80 kg/h. The 300 series central granulators, which are as compact as they are powerful, shred thick-walled moldings, sheets, sprue cakes, pipes, and profiles. And the MDSGi 1500/600 wet granulator equipped with a forced feed system, which was premiered at Fakuma 2023, offers an unprecedentedly good ratio of throughput to energy consumption. It produces flakes of consistently optimum quality, as well as a particle size distribution and geometry that are perfect for further processing.

## Plastics Recycling Award Europe 2024

■ At PRSE in Amsterdam, the DischargePro control system from EREMA's POWERFIL business unit was presented with the Plastics Recycling Award Europe in the "Recycling Machinery Innovation of the Year" category. The smart technology for the EREMA laser filter improves process stability over the entire operating period and reacts automatically to fluctuations during the recycling process.

"We have put a lot of effort into developing this technology. I am therefore particularly delighted to accept this award on behalf of the entire team today," says Robert Obermayr, Head of the POWERFIL business unit at EREMA, at PRSE 2024. The DischargePro system automatically compensates for fluctuations in the input material, thereby ensuring uniform thickening during melt filtration and thus a consistent process. Depending on the application and contamination, POWERFIL was able to reduce melt loss by up to 50 percent with the DischargePro compared to the previous EREMA laser filter control system. These facts convinced the jury, who described the technology as an intelligent technological advance in the extrusion process.



With the DischargePro control system, POWERFIL significantly increases the degree of automation in the filter process. The innovative discharge control system reacts to specific disruptions in the process. In this way, the speed of the scraper star is adjusted at short notice and returns to the setpoint speed as soon as the contamination peak has been discharged. Furthermore, the control system also recognizes changes in throughput and adjusts the discharge rates accordingly. In the event of a higher pressure drop across the filter screen, which is

*Robert Obermayr, Head of the POWERFIL business unit at EREMA, happily accepted the award at the PRSE in Amsterdam (Photo Credits: PRSE 2024)*

caused by a higher viscosity of the melt, DischargePro adjusts the setpoint value to ensure a consistent discharge rate. Long-term changes, such as the condition of the filter screen, are also taken into account in all adjustments.

EREMA Group  
 ➔ [www.erema.com](http://www.erema.com)

## New Cam-Lock Design Introduced

■ Guill Tool, the global leader in extrusion tooling, recently announced the availability of its Cam-Lock design on various crossheads.

The Cam-Lock is the same as supplied on the Bullet and will be supplied on additional heads, where applicable. It allows quick and easy assembly and disassembly of the crosshead and eliminates the socket head caps screws. By removing and replacing the internals, a different profile can be extruded in minutes rather than hours. Since the cam lock resets the internals in the right configuration every time, there's far less chance of error, compared

to the assembly and misalignment issues with socket set screws. The Cam-Lock offers several features such as: it takes only ½ turn to remove and install the deflector tip and no fastening hardware is required. Additional features include fast tool changes (threaded retaining ring for the die and threaded tip retainer), dies remove from the front and tips from the back, tooling retainers for gum space adjustment, vacuum connections, simplified cleaning and reduced downtime and operating costs.

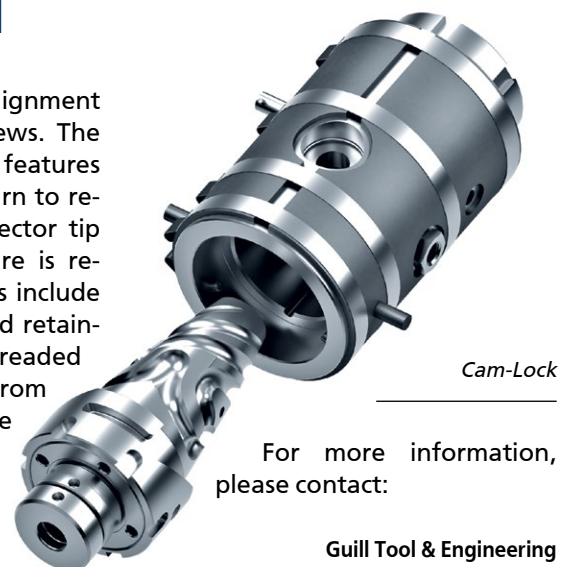

Cam-Lock

For more information, please contact:

Guill Tool & Engineering  
 Tom Baldock, Sales Manager, Extrusion  
 ➔ [tbaldock@guill.com](mailto:tbaldock@guill.com)

## UMAC® – Ultrasonic Measurement & Control Systems

■ ZUMBACH Electronic has over 30 years of experience in the development and sales of ultrasonic measurement systems for the measuring of wall thickness and concentricity of various materials including plastics, rubbers and metals. The great success of this technology and the flexibility it brings outperforms all alternative technologies. It is the only solution that makes it possible to measure and recognize similar materials as individual layers in co-extrusion applications.

Building on this success and the requests of their customers worldwide, the ZUMBACH team is pleased to launch the new compact A-series transducer holders, which optimise and extend the possibilities.

Due to high demand in specific applications, such as medical applications and fiber optics, ZUMBACH Electronic has released its new A-

series range of transducer holders for UMAC® control systems. The innovative design allows the use of 4 or 8 measuring transducers. Compatibility with the extensive range with different operating frequencies ensures measuring success in all applications. An integrated water flow distribution is standard and ensures that air and gas bubbles are removed from the measuring range, which is optimised for measurement reliability.

The top transducer, when in place, is removable, allowing for easier machine setup. Integrated guide solutions ensure product centralization. Optional height adjustment solution allows for under-bath or over-bath adjustment (vacuum/open-bath extrusion).

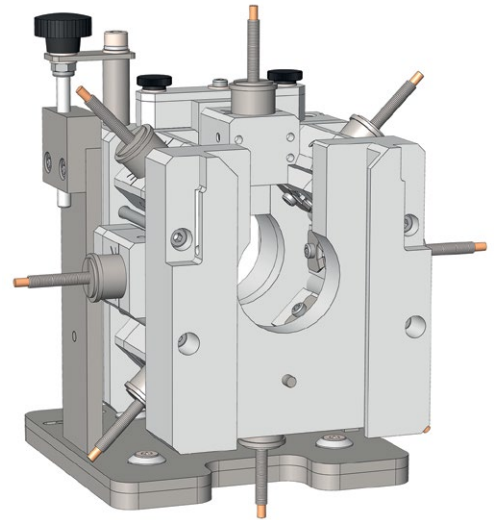

A-Serie Transducer Holder

ZUMBACH Electronic AG  
[www.zumbach.com](http://www.zumbach.com)

## Subsidiary in Bharat (India) Founded

■ Lindner continues its expansion with the foundation of Lindner Recyclingtech Bharat (India) LLP with its headquarters in Delhi. Together with Chirag Verma, Co-owner of Lindner Bharat, and Ganesh Karankal, Sales director of plastics recycling, the aim in this dynamic environment is to develop sustainable recycling solutions for the waste and plastics industry.

India, with its 1.4 billion people, is the second most highly populated country in the world and is presently the fifth largest economic power. While about 62 million tonnes of waste is produced every year and rising, the rate of recycling, which varies depending on the type of waste and region, still has growth potential. A range of initiatives by the Indian government are intended to raise the population’s awareness of this issue and help to increase the amount of waste recycled. However, as well as regulation, recycling requires appropriate technologies so that the wide range of reusable materials – including plastics, elec-



tronic scrap, and commercial, industrial and domestic waste – can be fed back into the circular economy.

“By founding Lindner Recyclingtech Bharat we want to contribute to returning greater quantities of reusable materials back into the loop or the circular economy. This

*From left: Patryk Max, Chirag Verma, Ganesh Karankal, Gerhard Gamper, Manuel Lindner (Copyright: Lindner Recyclingtech)*

needs the right shredders and system solutions as well as the relevant expertise. Together with Chirag

Verma and Ganesh Karankal, who are both experienced and respected businessmen, we wish to promote the expansion of sustainable recycling solutions in the Indian market and contribute our expertise," says Manual Lindner, CEO and owner of Lindner Recyclingtech.

Lindner Recyclingtech is considered a pioneer in the recycling industry. The founding of Lindner Recyclingtech Bharat adds another site to the subsidiaries in Germany, the USA, Singapore and France. Lindner, with its mobile, semi-mobile

and stationary shredders, also provides turnkey solutions for the processing of refuse-derived fuels (RDF) and plastics recycling. "Lindner has been manufacturing RDF successfully for many years. With Lindner Washtech we also have a wealth of experience in plastics recycling, which will continue to grow thanks to the cooperation with Erema, the branch leader in extrusion," asserts Ganesh Karankal, sales director of plastics recycling.

Chirag Verma, Co-owner of Lindner Bharat, is also enthusiastic

about the partnership. "India is a densely populated country with huge volumes of waste. According to estimates, the mountain of rubbish will rise to more than 400 million tonnes by 2050. There is a lot to do in the area of recycling. Together with Lindner, we want to support the efforts of the waste and recycling economy in India and are looking forward to this challenge."

Lindner

www.lindner.com

## Realignment

■ Since 2020, BDI-BioEnergy International GmbH (BDI) and Next Generation Elements GmbH (NGE) have partnered to develop SynCycle technology, based on the T:Cracker, for the chemical recycling of plastics. They have worked together to establish an industrial demonstration plant for SynCycle technology in collaboration with KRUWE GmbH in Kühnsdorf/Carinthia/Austria.

The joint efforts have successfully combined individual expertise into a comprehensive process solution. As part of their alliance, BDI, in collaboration with Kanzler Verfahrenstechnik GmbH (KVT), EOSS Industries Holding GmbH (EOSS), and the Rieckermann Group, will now take over the marketing and further development of SynCycle technology. The know-how developed by NGE and the T:Cracker product for processing polyolefins into pyrolysis oil will be adopted by BDI. Moving forward, the reactor process technology will be further developed at the Kühnsdorf site, and the technology will be rolled out worldwide as part of customer projects.

They have already acquired a first reference customer from Europe who will industrially employ SynCycle technology starting in 2025. NGE, as part of the NEXT GENERATION GROUP, will now focus intensively on the experiences gained with preparation

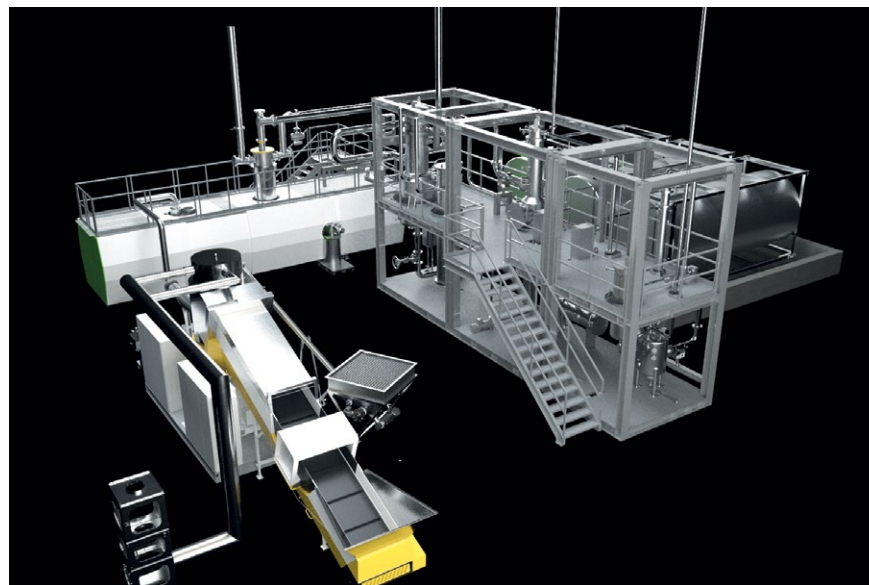

Reference plant at SynCycle Operations GmbH (Kühnsdorf/ Carinthia/ Austria)  
(Picture: NGH)

technologies concerning dry, wet, and melt preparation. The synergy of these preparation technologies is a significant success factor for the implementation of projects in mechanical and chemical recycling toward a sustainable circular economy. The experience and knowledge regarding the end application and end product enable the NEXT GENERATION GROUP, with its leading companies Next Generation Recycling GmbH (NGR) for melt preparation/extrusion and HydroDyn Recycling GmbH for wet preparation/washing technology, to technologically conceptualize, design, engineer, and implement comprehensive solutions, providing customers with a qualified technology partner along the entire value chain from plastic waste to product.

As part of the realignment, NGE has transferred its shares in SynCycle Operations GmbH to BDI. The pyrolysis technology for biomass, "PyroDry" and "PyroPower," which are also owned by NGE, remain unaffected by these changes and will continue to be developed independently.

NEXT GENERATION GROUP

www.next-generation-group.com  
www.ngr-world.com  
www.nge.at  
www.hydrodyn.de  
www.nga.at



## Investment in Upgrade Alpha Carbone Facility

■ Orion announced it is investing in Alpha Carbone, a French tire recycling company. The partnership will enable Alpha Carbone to scale up and produce commercial volumes of tire pyrolysis oil and recovered carbon black.

The cooperation also includes a long-term supply agreement with Orion as the exclusive customer for the tire pyrolysis oil produced by Alpha Carbone. The oil will be used by Orion to manufacture circular carbon black for tire and rubber goods customers.

“This investment enables Orion to make large-scale volumes of circular grades of carbon black for our rubber customers who are seeking sustainable solutions,” Orion CEO Corning Painter said. “It further strengthens Orion’s position as an innovator focused on the future and accelerating the transition to a circular economy.”

An estimated 500,000 metric tons of tires are discarded annually in France. For years, Orion has been working closely with major tire companies to develop circular carbon black. Tire pyrolysis is the only proven technology to produce circular carbon black that can be used in new tires.

Alpha Carbone’s tire pyrolysis process takes the discarded end-of-life tires and exposes them to high temperatures, removing wire, mesh and other materials. The process also reduces the tires to synthetic gas, recovered carbon black and tire pyrolysis oil.

Orion is the only company that has made circular carbon black from 100% tire pyrolysis oil as a feedstock. The company has also demonstrated that its circular products can replace virgin carbon black in many applications.

Alpha Carbone’s plant is expected to start up in late 2025. Besides the pyrolysis oil supplied to Orion, Alpha Carbone will sell the recovered carbon black to its own customers primarily under long-term contracts.

“This investment will allow Alpha Carbone to bring its Dole, France, facility to the best industrial level in order to supply the growing demands for quality recovered carbon black and tire pyrolysis oil to our customers. This new step aligns with the strategy of Alpha Carbone’s main shareholder, Alpha Recyclage Franche Comté, to offer the best possible solution for recycling end-of-life tires,” said Laura Pech, CEO of Alpha Carbone.

Orion S.A.

 [orioncarbons.com](http://orioncarbons.com)

## Subsidiary Opened

■ KRAIBURG TPE announced the official opening of its subsidiary, KRAIBURG TPE UK Ltd. This strategic move underscores the company’s commitment to serving the important UK market directly. It marks a pivotal milestone in the company’s development to further enhance local customer services.

The United Kingdom has long been a pivotal market for KRAIBURG TPE with numerous well-known clients and successful collaborations. However, evolving dynamics presented challenges in maintaining optimal service standards since 2020. Collaborating closely with the longstanding partner, Abbey Polymers, KRAIBURG TPE diligently addressed these challenges. In January 2024, KRAIBURG TPE UK Ltd. initiated its business and warehousing operations. With a dedicated sales office in Stafford and a strategically located warehouse in Stoke-on-Trent, it is poised to deliver customer-centric solutions and uphold its hallmark service excellence. This strategic expansion re-



flects KRAIBURG TPE’s unwavering commitment to meeting the evolving needs of clients and further expand the company’s presence in the UK market.

KRAIBURG TPE announced Michal Mucha as the main UK representative for KRAIBURG TPE UK Ltd. With a wealth of experience spanning over a decade in plastics and automotive sectors, Michal is primed to further extend the company’s presence in the UK market. His appointment underscores the company’s commitment to delivering

*The official opening of KRAIBURG TPE UK Ltd underscores the company’s commitment to serving the important UK market directly. Michal Mucha, Technical Sales Manager UK, is supported by Philip Jahn, Technical Sales Manager, and both report directly to Nikolaus Weiss, Head of Sales at KRAIBURG TPE (f. l. t. r.) (Image: © 2024 KRAIBURG TPE)*

exceptional customer experiences and fostering partnerships. Michal Mucha is supported in his role by Philip Jahn, Technical Sales Manager EMEA, who has been in charge

of the UK market for KRAIBURG TPE since 2020 and who has extensive experience of the local requirements.

Expanding operations in the UK not only reinforces the company's commitment to the region but also streamlines the purchasing process for customers. By establishing a lo-

cal presence, lead times and shipping costs are significantly reduced, providing customers with greater convenience and efficiency in their procurement journey. This localization strategy aligns with the growing trend towards regionalization in supply chain management, enabling KRAIBURG TPE to respond swiftly to

market demands and expand overall service levels. Moreover, customers benefit from seamless navigation in regulatory frameworks, ensuring compliance with local standards and regulations.

**KRAIBURG TPE**

► [www.kraiburg-tpe.com](http://www.kraiburg-tpe.com)

## Sales Engineer for Fluid Coatings in China Appointed

■ Nordson Corp.'s Polymer Processing Systems division has announced the appointment of Rachel Xu as Sales Engineer for the fluid coating business in the Far East. Xu will provide sales and technical support, maintain existing customer relationships, and drive market expansion for Nordson's fluid coating business.

She will report directly to Jie Hu, Senior Sales Manager for Nordson in China/South Korea. Rachel Xu will also oversee the distribution network for Nordson's Premier™ and Ultracoat™ die slot coating product line.

"Rachel's broad-based sales and technical experience make her uniquely qualified for this new role,"

said Jie Hu. "I'm confident that she will leverage her expertise with key customers while leading new growth efforts in key fluid coating markets."

"I'm thrilled to join the Nordson team as the company focuses on an ambitious growth strategy in Asia for fluid coating applications," said Rachel Xu. "I look forward to strengthening relationships with key customers and working to bring new business opportunities."

Rachel Xu previously served for three years as a sales manager for NINGBO IRRIRICH WATER SAVING TECHNOLOGY where she managed customer sales, marketing, and technical initiatives. Prior to joining Nordson, she worked for one year as a Business Development Man-



Rachel Xu

ager at Trendbank, where she cultivated a broad network of industry resources and contacts in the fluid coating market.

**Nordson Polymer Processing Systems**

► [www.nordsonpolymerprocessing.com](http://www.nordsonpolymerprocessing.com)

## New Compostable Products

■ Swedish company GAIA Biomaterials' limestone-based bioplastic material Biodolomer has received more compostability certifications from BPI in the USA. The new certifications cover Biodolomer T and enable the production of compostable products that require rigid materials, such as drinking mugs and food trays.

Gaia Biomaterials recently received its first BPI compostability certificate for the thinner grades of Biodolomer suitable for film applications. The new certificates

are given to Biodolomer T for Extrusion, Granulates, Sheet Resin, and Thermoforming Resin with a maximum thickness of 1000 microns.

Biodolomer T is suitable for products that require a rigid material, such as beer and coffee cups, and food trays. "This means that we can now offer a USA-certified compostable material for a number of new applications that require a thicker and more rigid material", says Gaia Biomaterials CEO Peter Stenström. BPI (Biodegradable Products Institute) is North America's leading authority on compostable products and packaging. They ensure that all claims of compostability are supported by scientific evidence as requested by the FTC. Biodolomer T already has a European certification from the German certification bureau DIN Certco. Like other Biodolomer materials, it is based on limestone and does not result in any microplastics. It also reduces CO<sub>2</sub> emissions by up to 80% when incinerated.



**GAIA Biomaterials AB**

► [www.gaiabiomaterials.com](http://www.gaiabiomaterials.com)

## New Product Line

The Cologne-based company BIO-FED has launched a new product line under the brand name M-BIOBASE®. The plastic compounds in this product line are made partly or completely from biobased and/or biomass-balanced materials.

Thanks to the use of renewable raw materials, M-BIOBASE® compounds have an improved CO<sub>2</sub> footprint (product carbon footprint) compared to conventional fossil-based plastics.

One example of this is the used biomass-balanced polypropylene (PP), which is obtained from waste e.g. residues from vegetable oil refining or used cooking oil (UCO). The compounds produced with this mate-

rial are ISCC PLUS certified, which guarantees the traceability of the sustainable material flow along the entire value chain.

Another example of the use of renewable raw materials in

Three M-BIOBASE® compounds with different proportions of wood fibres (© BIO-FED)



M-BIOBASE® compounds is the use of organic fillers such as wood or lignin from waste streams from the timber industry.

M-BIOBASE® materials are suitable for injection moulding and extrusion and can be used for a variety of applications. The product portfolio is also being continuously expanded.

In addition to the M-BIOBASE® portfolio, BIO-FED supplies the matching masterbatches AF-CirColor® (colour masterbatches), AF-CirCarbon® (carbon black concentrates) and AF-CirComplex® (additive masterbatches), which are based on biomass-balanced carrier material and therefore also contribute to reducing the CO<sub>2</sub> footprint.

BIO-FED  
Branch of AKRO-PLASTIC GmbH  
[www.bio-fed.com](http://www.bio-fed.com)

## Lightweight Tubes for Electric Vehicles

NORMA Group has been awarded a major contract to equip a new platform for small to medium electric passenger cars with lightweight tubes for the battery thermal management system. The customer's vehicle platform encompasses several car models and targets to enable efficient city mobility. The contract is worth more than EUR 30 million. Starting in December 2026, NORMA Group will deliver around 1.4 million tubes to the customer per year.

CEO Guido Grandi: "Large-scale production and availability of small and medium electric vehicles will be a main driver for the transition towards a low-emission, more climate-friendly mobility. This contract proves that with our engineering expertise, our standardized quality management and our global manufacturing footprint we are the right partner for leading car manufacturers as they broaden and scale up their portfolio of battery-electric vehicles."

The tubes are made of thermo-plastic elastomer, a light and flex-

ible material. With its material and design quality, a TP Flex tube significantly reduces the pressure drop of the fluid that flows through it. The tube is therefore well suited for use in the thermal management systems of electric vehicles where it is particularly challenging to keep the pressure in the cooling circuit evenly high.

The tubes will be manufactured at NORMA Group's plant in Subotica, Serbia. For the contract, the company will invest in new ergonomic assembly lines and in modernizing existing thermoforming equipment.

NORMA Group  
[www.normagroup.com](http://www.normagroup.com)



NORMA Group's TP Flex tube is used in the battery thermal management system

## Analysis Released: Impact of Fed Policy on Housing and Plastics

■ The Plastics Industry Association (PLASTICS) has released an official analysis of the impact of Federal Reserve policy on housing and the plastics industry, authored by PLASTICS Chief Economist, Dr. Perc Pineda. Dr. Pineda writes, "On the housing market and its relation to

the demand for plastics, the outlook hinges on the trajectory of interest rates going forward. Economists and financial industry observers have debated the potential outcomes of the Fed's monetary policy tightening cycle, with a soft landing being seen as beneficial for the

housing market and the plastics industry."

To read the full analysis on the PLASTICS blog page:

➔ <https://www.plasticsindustry.org/blog/the-impact-of-fed-policy-on-housing-and-plastics/>

## Plastics in Healthcare: Trends and Forecast

PLASTICS has released an official analysis of the impact of plastics in the healthcare sector, authored by PLASTICS Chief Economist, Dr. Perc Pineda. Dr. Pineda writes, "Those in the plastics industry and healthcare sector understand the crucial role of plastics in saving lives. Plastics has been a trusted material for many years, relied upon by pharmaceuti-

cal companies, medical equipment manufacturers, laboratories and research facilities, and healthcare professionals."

To read the full analysis:

➔ <https://www.plasticsindustry.org/blog/plastics-in-essential-healthcare-trends-and-forecast/>



Dr. Perc Pineda

## Chief Engineer Celebrates 60 Years of Service

■ It isn't every day that you see an employee with 60 years of service to a company. Recently, Farrel Pomini celebrated its Chief Engineer, Doug Mosher, who is just that. Doug joined Farrel Corporation fresh out of college in 1964, with a BS in Mechanical Engineering from Clarkson College of Technology (Clarkson University today).

Doug was hired into Farrel's 'Engineer-in-Training' program, which was a one-year rotation through the various divisions of the company, and a program that all new engineers participated in. He then worked as an Engineer in the Banbury® Mixer Department, and then on the early Farrel Continuous Mixers which were an evolution of the Banbury®. The FCM™ was originally developed for rubber processing before finding its footing in plastics compounding.

Doug also worked on the first-generation Farrel Compact Processor (mixer and extruder together on a unitized frame).

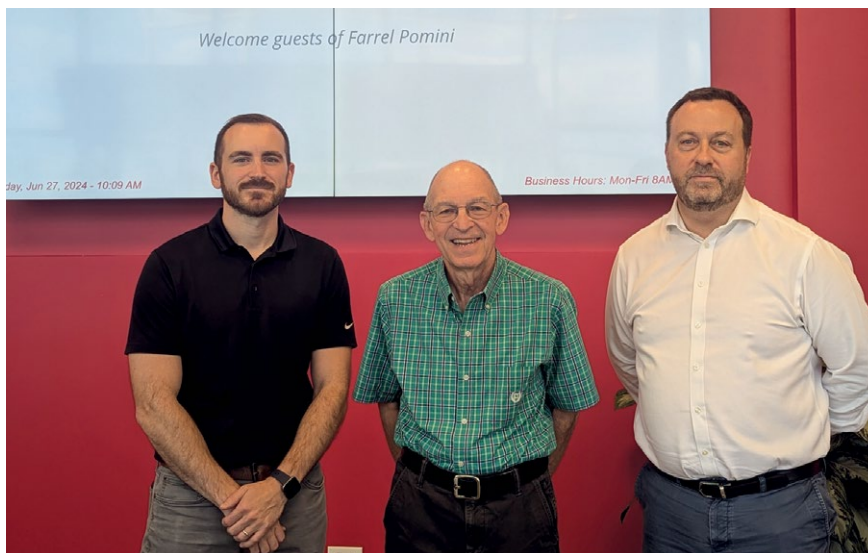

The photo is showing Doug Mosher standing with Farrel Pomini Engineering Department Manager, Steve Carlson (left) and Farrel Pomini President, Paul Lloyd (right)

Highlights of Doug's 60-year career at Farrel are too numerous to mention. Some include:

In 1997, Doug became Farrel's Engineering Manager responsible for Con-

tinuous Mixers, Extruders and Underwater Pelletizers including overseeing large petrochemical projects.

Today, Doug is Chief Engineer at Farrel and while he is semi-retired,

he is still very much an important contributor to the company.

Paul Lloyd, President of Farrel Pomini, said: "Doug is nothing less than a true legend. He has had an absolutely amazing career and contribution to Farrel Pomini. Sixty years of service is a never to be repeated achievement, but it's not the whole story," said Lloyd. "Doug's professional-

ism and engineering knowledge, which were applied every day, are as much a feature of Doug's career as its longevity. Everyone at Farrel Pomini has a debt of gratitude to Doug."

FARREL POMINI

www.farrel-pomini.com

## Statement on White House Federal Action Announcement

■ The Plastics Industry Association (PLASTICS) announced its disappointment in the White House's Mobilizing Federal Action on Plastic Pollution: Progress, Principles, and Priorities.

"We are disappointed in today's White House announcement, which arbitrarily singles out plastic under the false pretense of a lower environmental impact," said Matt Seaholm, PLASTICS President and CEO. "The Plastics Industry Association and its member companies are dedicated to keeping plastic waste out of the environment, and we continue to collaborate with policymakers at all levels of government to achieve this goal.

Instead of targeting plastics, we support investing in improving our country's recycling infrastructure and are pleased to see this priority included in the White House's strategy. New innovations, like advanced recycling, which increase the efficiency, amount, and types of plastics that can be recycled, must not be stifled. Furthermore, we support well-crafted extended producer responsibility policies and reasonable nationally recognized recycled content requirements.

Plastic as a material continues to offer unparalleled safety, protection, and efficiency and can be reused and recycled, reducing our overall resource needs. An inde-

pendent analysis of plastic and its alternatives showed plastic was better for the environment in 13 out of 14 common applications. The White House's announcement does not acknowledge this truth and will not get us closer to our sustainability goals.

Our industry is ready to come to the table and work with the Administration and Congress to keep plastic waste out of the environment. Instead of implementing arbitrary bans that don't address our environmental challenges, we need to collaborate on sound policies that will truly help us achieve circularity," concluded Seaholm.

## White House Position Change on Plastic Production Caps Strongly Opposed

PLASTICS released the following statement on the White House's decision to change its position and support limiting virgin plastics production as part of the UN Plastics Agreement currently being negotiated:

"The White House's misguided reversal in support of plastic production caps is not only impractical but directly harmful to all U.S. manufacturers and will get us no closer to reaching our shared environmental goals," said Matt Seaholm, President and CEO of PLASTICS. "The plastic industry is the seventh largest manufacturing industry in the United States and employs one million people. With this decision, the White House has turned its back on Americans whose livelihoods depend on our industry, as well as on manufacturers in all sectors that

rely on plastic materials. Plastic offers unparalleled safety, protection, and efficiency and can be reused and recycled, reducing our overall resource needs. An independent study confirms plastics have lower total greenhouse gas contribution than alternative materials. Yet, the White House's decision ignores these facts in favor of misinformation spread by anti-plastic activists. Furthermore, this reversal has undermined U.S. negotiators' influence in UN negotiations as other countries know this extreme position will not receive support in the U.S. Senate. We are dedicated to keeping plastic waste out of the environment and believe we need to work together to achieve this. However, the White House's drastic position change will not accomplish this goal, only set us back."



Matt Seaholm

The Plastics Industry Association (PLASTICS)

www.plasticsindustry.org

## Leadership Change at US Site Announced

■ BHS-Sonthofen announced the appointment of Garrett Bergquist as new President and General Manager of BHS-Sonthofen Inc., effective July 8, 2024. Based in Charlotte, North Carolina, BHS-Sonthofen Inc. is the wholly owned subsidiary of BHS-Sonthofen located in Sonthofen, Germany.

"We are delighted to welcome Garrett Bergquist back to BHS," says Dennis Kemmann, CEO of the BHS-Sonthofen group of companies. "Garrett's extensive background in chemical engineering and his profound understanding of the industry make him the ideal leader for our team in North America."

Bergquist brings a wealth of experience and a proven track record in the engineering and filtration industries. His journey with BHS-Sonthofen Inc. began in 2014, where he initially focused on laboratory and pilot-scale testing as a process engineer. His role evolved to encompass filtration equipment selection, sizing, scale-up, commissioning, and troubleshooting. During that time, through Bergquist's work as applications engineer, the largest ever indexing belt filter produced by BHS-Sonthofen group, was sold. By the end of his first tenure at BHS in 2021, he had risen to the position of Sales Engineer for the Process Division.

In between his tenures at BHS, Bergquist served as the Director of Sales and Business Development at Steri Technologies, a Long Island, NY-based manufacturer of batch filtration equipment. His exemplary work earned him a nomination and election to the American Filtration Society Scientific Committee in 2023.

*Based in Charlotte, North Carolina, BHS-Sonthofen Inc. is the wholly owned subsidiary of BHS-Sonthofen located in Sonthofen, Germany*



*Garrett Bergquist is the new President and General Manager of BHS-Sonthofen Inc. His main goal is to put the customer first by establishing a culture of diligence and responsiveness*

Reflecting on his decision to return to BHS-Sonthofen, Bergquist states, "As a cutting-edge equipment manufacturer, BHS provides expert knowledge that allows us to push the boundaries of equipment application to meet new and exciting market demands. With the emerging markets in battery material production and recycling, as well as green initiatives surrounding the circular economy of plastics, we are well-positioned to meet the new requirements of the Green Chemistry Revolution. When I was offered the chance to return to BHS in a leadership role, I was excited to rejoin a company that is poised to be at the forefront of these important industry developments."

Garrett Bergquist is committed to elevating BHS-Sonthofen Inc.'s customer service standards. He emphasizes, "In an industry where many offer similar equipment, our proximity to North American customers, dedication to service, and filtration know-how should set us apart. As President and Managing Director of BHS USA, my main goal is to put the customer first by establishing a culture of diligence and responsiveness, while offering customer-focused initiatives that allow BHS to provide the highest quality parts with reliable delivery times."

BHS-Sonthofen Inc.  
[www.bhs-sonthofen.com/en](http://www.bhs-sonthofen.com/en)

## RealClearEnergy Features NCSL Op-ed

■ As the National Conference of State Legislatures Summit convenes in Louisville, Kentucky, "RealClearEnergy" has featured an op-ed written by Plastics Industry Association's Vice President of Government Affairs, Jason Eberstein. The piece highlights how the plastics industry and legislators can work together to increase recycling rates and reach our shared sustainability goals.

"This week in Louisville, lawmakers from all over the country will convene at the National Conference of State Legislatures (NCSL) Summit to discuss policy, collabora-

tion and solutions to problems impacting their states. We encourage them to seize opportunities to solve the environmental challenges we face and address the need for recycling infrastructure as it offers a promising area for bipartisan agreement and cooperative action."

To read the full op-ed:

► [https://www.realclearenergy.org/articles/2024/08/07/industry\\_and\\_legislatures\\_can\\_boost\\_recycling\\_together\\_1050169.html](https://www.realclearenergy.org/articles/2024/08/07/industry_and_legislatures_can_boost_recycling_together_1050169.html)

## Keynote Speaker Announced for Inaugural 2024 National Plastics Conference

■ PLASTICS has announced Chris Dyer, bestselling author and speaker on workplace culture, as the keynote speaker for the PLASTICS' inaugural 2024 National Plastics Conference. Dyer will offer the audience innovative perspectives on leadership to improve company culture and empower individuals and organizations to discover new successes.

"We're thrilled to have Chris Dyer deliver the keynote address at the first-ever National Plastics Conference," said PLASTICS President and CEO Matt Seaholm. "Chris will bring his innovative leadership perspectives to our audience, focusing on how to strengthen company culture and inspire organizations to reach new levels of success. We're excited for him to share his expertise as we continue to innovate and strengthen the plastics industry."

Dyer's keynote is scheduled for October 15th at 9:45 AM CT. The National Plastics Conference takes place in Houston, Texas from October 14-17, 2024. This conference, designed "by industry, for industry," unites the entire plastics supply chain for industry-driven education, collaboration, and progress. Attendees from across the supply chain play an active role in shaping the future of the plastics industry, creating cutting-edge advancements, and building valuable connections that will propel their businesses and the industry forward.

Chris Dyer is a recognized company culture and remote work expert. As a former CEO managing thousands of people, his companies consistently were named a best place to work. They have also been

named a fastest growing company by Inc Magazine 5 times. Dyer routinely consults and speaks, and Inc Magazine ranked him as the #1 Leadership Speaker on Culture. He has two bestselling books *The Power of Company Culture* and *Remote Work*, and has been named #5 on the LeadersHum Power List, a Top 50 Voice in Leadership, a Top 40 Change Management Guru, a Top 50 Global Thought Leader, and a Top 50 leadership podcast, Top 50 HR Leaders Shaping the Future of Work, and a Top 101 Global Employee Engagement & Experience Influencers by Inspiring Workplaces and Work Buzz.

For more information about the National Plastics Conference:

► <https://nationalplasticsconference.org/>

## Enhanced Website to Elevate Customer Experience Launched

■ SI Group announced the relaunch of its website. Designed to deliver a much-improved user experience, the new site design reflects SI Group's commitment to captivating customers and website users. Key Features of the New SI Group Website:

\* Improved Product Search – Capabilities: The revamped website offers a more intuitive and powerful product search functionality. Customers can now find detailed information on SI Group's extensive portfolio with ease, ensuring that they can quickly locate the products that meet their specific applications, markets, and technologies.

\* Access to Comprehensive Resources: The site includes a rich library of resources, including technical documents, brochures, and videos. Making product resources

more easily available helps support customers in their research and decision-making processes.

\* User-Centric Design: The new website boasts a modern, user-friendly interface that improves navigation and accessibility. The streamlined design ensures that visitors can readily find information, enhancing the overall browsing experience.

\* Improved Customer Support Tools: The site now features improved customer support tools, including a Contact Us section that provides customers with more efficient access to SI Group's resources, including technical experts.

The relaunch of the website is part of SI Group's broader strategy to invest in technology that helps drive customer satisfaction and operational excellence. In addition to

the new website platform, the company has also expanded its focus on research and development (R&D), reinforcing its position as an industry leader in delivering cutting-edge additive solutions.

"We are excited to introduce our new website, which is a testament to our dedication to improving the overall customer experience," said Brooke Manrique, Senior Vice President of Human Resources and Communications. "This relaunch represents a significant milestone in our ongoing journey to enhance our digital presence and provide our customers with the tools and resources they need to be successful."

SI Group  
► [www.siigroup.com](http://www.siigroup.com)

## Innovations in Conductive Additives Showcased at 2024 IWCS Cable & Connectivity Industry Forum

■ At the IWCS 2024 Cable & Connectivity Industry Forum, global specialty chemicals company Orion will showcase its high-performance conductive additive portfolio, designed for wire and cable and other conductive applications at Booth #206.

Orion will highlight developments underway, including its latest innovation PRINTEX® kappa 60 conductive additive, designed for conductive polymer compounds and a strong choice for wire-and-cable applications. The IWCS 2024 Cable & Connectivity Industry Forum will take place October 14–17, 2024, in New Providence, Rhode Island.

Orion conductive additives increase cable service life by delivering high product purity, desired conductivities, superior surface smoothness and UV protection to medium-voltage (MV) distribution and high-voltage (HV) transmission cables.

“Over time, we’ve optimized the colloidal properties of legacy conductive additives to ensure excellent dispersibility and product cleanliness in our newest grades plus those in development,” said Kevin Milks, Orion marketing manager for polymers and special applications.

PRINTEX kappa 60 conductive additive meets the dispersion and cleanliness requirements for wire and cable applications. In separate product developments, two new circular additives produced from end-of-life tire pyrolysis oil match the performance of regular, fossil-based specialty carbon black used in cable jacketing.

Plus, Orion’s premium, acetylene-based PRINTEX kappa 100 BEADS, launched at the IWCS 2023 Cable & Connectivity Industry Forum, offer excellent dispersibility, exceptionally high cleanliness, purity and conductivity, making them ideal for use in high-voltage (HV) electric transmission cables.

To increase acetylene black availability, Orion on April 9 broke ground on a plant in La Porte, Texas, that will be



*Orion conductive additives extend service life in wire-and-cable applications*

the only facility in the U.S. producing acetylene-based conductive additives for wire and cable, lithium-ion battery and other applications vital for the global shift to electrification. The facility is expected to begin operation in the second quarter of 2025.

“We look forward to providing the North American wire-and-cable industry a consistent supply of domestically produced acetylene-based conductive additives,” said Jennifer S. Stroh, Ph.D., Orion vice president of sales and marketing Americas. “We also look forward to customizing solutions for all wire-and-cable applications as we continue to develop new conductive products and travel the arc of innovation.”

At the 2024 IWCS Industry Forum, Scott Brewer, senior technical market manager, will present “Carbon black and conductivity in medium and high voltage cables” as part of the Materials technical track. He will present October 15 at 3:15 p.m.

Orion S.A.

➔ [orioncarbons.com](https://orioncarbons.com)

**IWCS 2024 Cable & Connectivity Industry Forum: Booth #206**

## New Plastics Demand Estimate Report Launched

■ PLASTICS has released the inaugural Plastics Demand Estimate Report. The report estimates the plastic demand estimate for May 2024 in the U.S. The monthly estimate for plastics products demand, serves as a valuable indicator for plastics processors and the entire plastics industry supply chain. The report will now be released monthly by PLASTICS, which is the only trade association providing this type of report and analysis.

“The Plastics Demand Estimate is a great new set of data that provides helpful market intelligence to our members and the industry at large. This is the only plastics demand estimate available monthly and I’m proud of our Chief Economist Perc Pineda’s work on putting this together,” said Matt Seaholm, President and CEO of PLASTICS.

“While demand will continue to vary monthly, the year-over-year change in plastics demand at cur-

rent prices and real demand, adjusted for inflation, has been more aligned in recent periods compared to 2021 and 2022,” said Perc Pineda, PhD, PLASTICS’ Chief Economist.

The Plastics Demand Estimate Report is available to PLASTICS’ members and non-members:

➔ <https://www.plasticsindustry.org/resource/plastics-demand-estimate/>



## In-Mould Film Solution for Large Format Containers Launched

■ Innovia Films, a material science pioneer and major producer of BOPP films, has announced the launch of a new solution for large format in-mould labelling containers. RayoForm™ ELR70 is a 5-layer semi-cavitated, one side matt and one side gloss film offering a reduction in density versus standard white films.

"The high stiffness of the film allows for bigger labels and larger sheet conversion, this product performs excellently on both PP and PE containers," explains Paul Watters, Product Manager Labels at Innovia Films.

"The new film grade was developed to support the in-mould labelling markets where sizable labels are the norm. Supporting a range of 5-25 litre containers easily," Paul continues.

The two-side treatment allows for the control of anti-static levels for the high-speed sheet feeding and moulding process giving optimal print and moulding performance.

Further information or a trial reel:

Innovia Films Ltd  
 labels@innoviafilms.com  
 ➔ www.innoviafilms.com



## Statement on White House Policy Change Featured

■ Fox News has featured a statement from PLASTICS' CEO and President, Matt Seaholm, in a recent article, "Plastic manufacturers push back after Biden administration agrees to support global goal to cap production." The piece reports on the White House's decision to change its position and support plastics production caps as part of the UN Global Plastics Treaty Agreement. In this statement, Matt Seaholm, the president and CEO of the Plastics Industry Association,

said the Biden-Harris administration's decision "turned its back" on residents whose livelihoods depend on the industry.

"The plastic industry is the seventh-largest manufacturing industry in the United States and employs 1 million people. With this decision, the White House has turned its back on Americans whose livelihoods depend on our industry, as well as on manufacturers in all sectors that rely on plastic materials," he said. "The White House's

misguided reversal in support of plastic production caps is not only impractical, but directly harmful to all U.S. manufacturers and will get us no closer to reaching our shared environmental goals."

To read the full article:

➔ <https://www.foxbusiness.com/markets/plastic-manufacturers-push-back-biden-administration-agrees-support-global-goal-cap-production>

# PO 4 400 CR – A Flexible Cross Head System for Barrier Pipes up to 400 mm

*Why barrier pipes? Because the aim is to protect a medium which is either inside or outside the pipe against permeation of (toxically) substances like gas or liquid.*

**P**ermeation is the penetration of a permeate such as liquid or gas or vapour through a solid wall. Permeation is directly related to the concentration gradient of the permeate. Permeation can be measured and Permeation works through diffusion. The permeate will move from high concentration to low concentration.

**Examples for barrier pipes are:** Pipes for fuel transportation – permeate is fuel. The outer PE jacket of pre-isolated pipe for district heating – permeate is oxygen which degrades the foam. Hot water pipe for floor heating – permeate is oxygen. Water transportation pipes – permeate are hydrocarbons from soil in urban or industrial areas can be contaminated by a number of toxic chemicals such as fuels, oil or hydrocarbons. Standard Polyethylene – used for portable water transportation is not resistant against diffusion of this chemicals.

The solution to avoid diffusion is to apply to the standard PE pipe a barrier layer based on plastic or non-plastic. Pipes with barrier materials based on non-permeable polymer, leads to a durable, fully-recyclable long living barrier pipe solution.

PE pipes with barrier layer have to fulfil EN 12201-3.

Following barrier material are in use: EVOH, PVDC, PA, PET, O-PET, OPP and others. The barrier polymer selection depends on permeate.

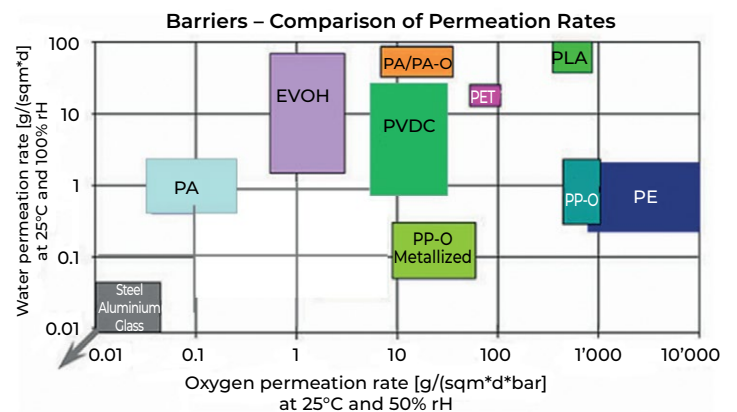
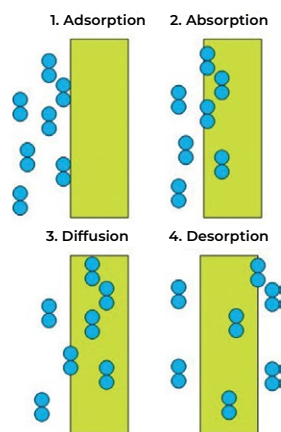

There are also non polymer barrier materials in use. Talcum increases the diffusion path and reduce permeability.

Aluminium is a non-plastic 100% barrier material having following disadvantages:

- Aluminium tape – coated with glue – is more expensive than plastic barrier material, butt welding of pipes is difficult especially for fittings and elbows.
- Coating process technology is more complicated.
- Higher investment in case of a new extrusion line.
- To convert existing line very complicated – wrapping unit and heating, scrap is contaminated with aluminium and difficult to recycle.

## Process technology

Basically we have 3 options to make barrier pipes:

**Option 1:** barrier pipe production with multilayer head:

The basic pipe as well the barrier layer is produced all together in one extrusion head at same time. The num-

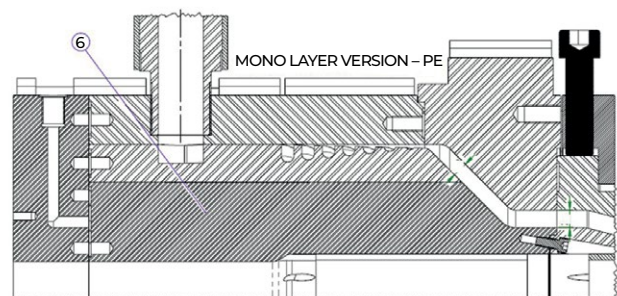
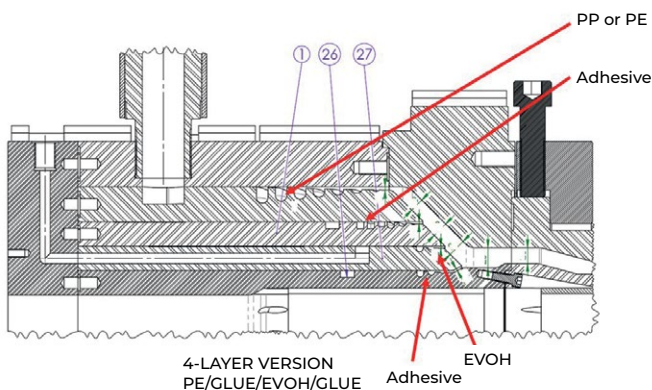

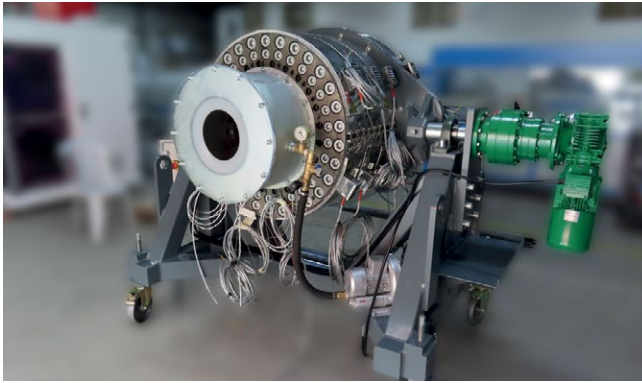

Backside of the cross head with temperature resistant sealing for vacuum

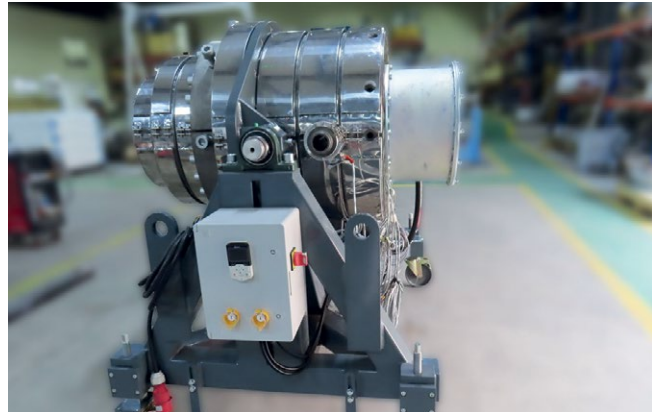

Side view of : PO 4 400 CR with control box to operate motorised turning as well PLC control via FC and motor speed of the blower. Melt inlet main layer outside and the melt inlet of other 3 layers at 0 / 45 degree and 90 degree from top

ber of polymer channels depends on pipe layer structure and can reach up to 5 layers in one single head. The structure is: basic pipe / barrier structure / outer protection layer.

**Option 2 :** standard pipe production + multilayer coating technology

The PE basic pipe is produced on a new or existing monolayer pipe extrusion line. The barrier layer is applied via a multilayer cross head located in front of the last spray tank.

**Option 3 :** standard pipe production + aluminium foil coating technology which can be made via wrapping or covering. The PE basic pipe is produced on a new or existing monolayer pipe extrusion line. The Aluminium foil is applied having glue coating on both sides or single side. The glue layer has to be activated by heat up to 180 °C by infrared or high frequency heaters, to get best adhesion to the basic pipe. Finally a cross head has to make the protection layer with PE or PP on top.

Due to some major disadvantages of option 1 the preferred system is to work with cross heads for option 2 and 3.

**Cross head Technology**

CONEXTRU has a concept of cross heads to cover process option 2 and 3 within a range from 32 up to 630 mm with different sizes of heads.

The concept is based on a 4 layer cross head. For all layers the proven helical spiral melt distribution system

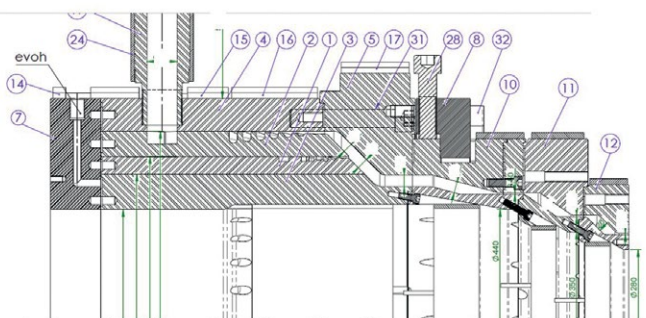

is used. For low viscosity materials like EVOH, glue, or PA and low throuput is a special very tiny and small geometry available. For the outer protection layer a conventional spiral geometry for high throuput, also used in standard heads, suitable for PP and PE is installed.

In case of using a polymer as barrier material the cross head version with 4 distributors is used.

In case of using aluminium foil the number of layers are depending on the type of Aluminium foil.

For Aluminium foils with double side coated glue layer, only the outer distributor needed. In this case 3 spiral distributor blocks are replaced against one block without melt distributor – just a simple blind block.

In case the Aluminium foil has a single side coating with glue – than the block without distributors is replaced by another block having one melt distributor for the glue. Than the cross head is in a 2 layer version.

In this version the Aluminium foil has the glue coating on a side to generate bonding to the basic PE pipe. The adhesive layer for bonding the aluminium to the outer layer is generated in the head.

The change from 1 layer to 2 layer or 4 layer can be done easy without dismantling the whole head. The exchange of blind block or block with distributors is done from backside of the head. Due to this special engineering design the cross head is flexible and can be used as cross head for barrier pipes with polymers as well as with aluminium or even as a simple one layer cross head for applying a PP protection layer.

A side channel compressor is foreseen to generate the vacuum. The vacuum is PLC controlled by the speed of the motor of the small compressor.

The die and mandrel change can be done from front side which make work easy in handling in case of dimension change. A special tool is part of delivery to make the horizontal mandrel change easy and simple.

# PET Bottle Recycling Solution from a Single Source

*For Indian preform and plastic packaging manufacturer Magpet Polymer Pvt Ltd, Coperion and Herbold Meckesheim are collaborating technologies in construction of an entire plant for bottle-to-bottle recycling from a single source. In addition to mechanical processing of used PET bottles, the recycling system encompasses all process steps leading up to extrusion with a ZSK twin screw extruder, including pelletizing and an SSP (Solid State Polycondensation) reactor.*

This PET bottle recycling system is designed for a throughput of 5,500 kg/h. It will deliver PET recyclate that is approved by the European Food Safety Administration (EFSA) and the U.S. Food and Drug Administration (FDA) for direct contact with food. Moreover, the PET pellets manufactured on this bottle-to-bottle line are brand owner approved.

“Magpet has always pursued the goal to be a first mover when it comes to embracing new technology,” said Devendra Surana, Managing Director of Magpet, a part of Magnum Group. “This PET recycling unit is a big step in that direction. And it goes hand in hand with our efforts to take over business responsibly for a bigger eco purpose. We are excited to partner with Herbold and Coperion to set up this state-of-the-art PET bottle recycling line in India.”

## Entire high-efficiency system from a single source

Magpet awarded the contract for the entire system to Coperion and Herbold Meckesheim, operating companies of Hillenbrand, as they have optimally coordinated their technologies and realized efficient plastic recycling solutions that consistently and reliably deliver high PET recyclate quality.

Coperion’s and Herbold Meckesheim’s bottle-to-bottle plants enable all recyclates to be processed together, even if they exhibit different IV (Intrinsic Viscosity) values or fluctuating bulk densities. What is more, the Coperion-Herbold solution saves on operating costs, logistics costs, and energy consumption in comparison to conventional PET recycling processes.

The bottle-to-bottle recycling system first processes the PET bottles into flakes. For this purpose, Herbold uses granulators with forced feeding and washing sys-

tem technologies that efficiently and gently process the PET to minimize material loss due to fines formation and thus maximize yield.

This preprocessing is followed by conveying and feeding into the ZSK recycling twin screw extruder. There, the PET regrind is gently melted, intensively dispersed, and processed into a homogeneous mass. The ZSK’s twin screw technology efficiently transfers the energy into the melt. Thanks to the twin screw extruder’s high 18 Nm/cm<sup>3</sup> torque, the PET’s residence time in the extruder is short. Processing takes place at low temperatures, polymer chain degradation is minimal, and the product quality achieved is high. Volatile components such as monomers, oligomers and water are removed from the melt and purged.

Following discharge from the ZSK recycling extruder, the still-warm material stream is transferred via a gear pump to an underwater granulator and an SSP reactor, where it is then condensed and decontaminated.

“In the bottle-to-bottle recycling plant for Magpet, we have united the advantages of Coperion and Herbold Meckesheim technologies. All process steps, from mechanical pretreatment to producing finished recyclate, are optimally coordinated to produce PET of high-quality – and with maximum energy efficiency,” says Jochen Schofer, Head of Sales Recycling at Coperion.

“With this bottle-to-bottle recycling system Magpet takes the next step in their journey. We wish Magpet every success and look forward to continuing to work together,” adds Mehmet Kaya, Sales Team Leader Asia for Herbold Meckesheim.

Coperion GmbH  
Theodorstr. 10, 70469 Stuttgart, Germany  
www.coperion.com

Herbold Meckesheim GmbH  
Industriestr. 33, 74909  
Meckesheim, Germany  
www.herbold.com

Magpet Polymer Pvt Ltd  
www.magnumgroup.in

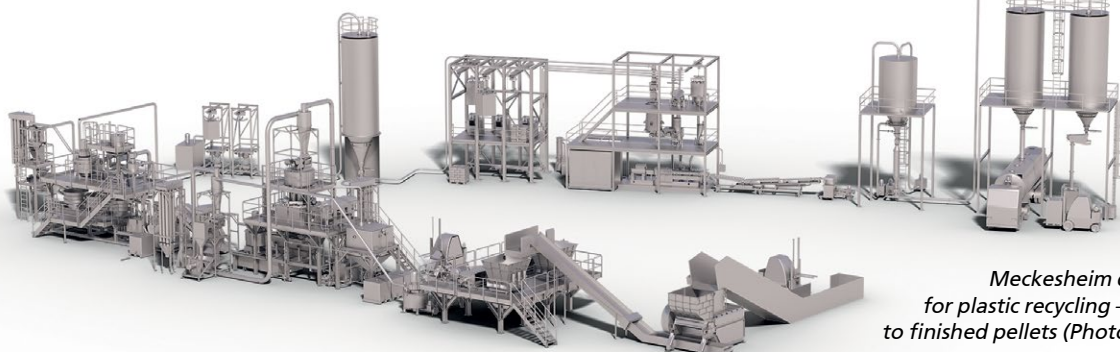

Coperion and Herbold Meckesheim design especially efficient plants for plastic recycling – from mechanical pretreatment to finished pellets (Photo: Coperion, Stuttgart Germany)

# Strong Partnership Drives Plastics Recycling in China

*Jiangsu Ceville New Materials Technology Co, Ltd, a leading Chinese recycling company, signed the purchase of another VACUREMA® plant in June 2024. The recycling specialist is thus investing in its fifth EREMA machine for the recycling of post-consumer and PET waste.*

Ceville and EREMA have enjoyed a successful partnership for several years. The signing ceremony at EREMA's headquarters in Ansfelden, Austria, was attended by representatives of the Chinese government, including a delegation from Zhenjiang Dantu District led by Mao Jian, Party Secretary of the Dantu District Committee. The visit of this high-ranking political and business delegation is seen as a sign of the Chinese government's respect for Ceville and EREMA, and recognizes the successful cooperation between the two companies.

Ceville, founded in China in 2018, specializes in the recycling of post-consumer material. Under the leadership of company founder and Managing Director Bin Huang, the company produces high-quality recycled pellets from PET, HDPE and PP and supplies various industries



worldwide. These use the pellets for food and beverage packaging, textile and automotive products and more.

*Bin Huang, Managing Director of Ceville, and Kurt Pichlmann, Head of Sales China at EREMA, seal their successful partnership at the signing ceremony in June 2024*

*Robin Roth, Managing Director at EREMA, and Kurt Pichlmann, Head of Sales China at EREMA, welcomed the delegation from the Dantu District to EREMA's headquarters in Ansfelden (Photo Credits: EREMA GmbH)*

## Increase in production capacity to 150,000 tons

"Our goal is to be a leading company for high-quality plastics recycling. We have concrete growth plans for this in the coming years,"

explains Bin Huang. Ceville's current recycling capacity is 60,000 tons per year. This is set to increase to 150,000 tons by the end of 2025, with a focus on rPET. "To achieve our ambitious goal, we need an experienced and reliable technology partner. We have found that partner in EREMA," emphasizes Bin Huang.

Four EREMA systems are currently in use at Ceville. In addition to an INTAREMA® TVEplus® including the ReFresher anti-odour technology – together a highly efficient combination for contaminated post-consumer waste - the recycling company also has three VACUREMA® systems for bottle-to-bottle recycling in operation. "What sets EREMA apart is the approval of its technologies for direct food contact by globally recognized European and North



American food safety authorities and global brand owners," says Bin Huang. Over the next few years, Ceville will be investing primarily in the expansion of PET recycling solutions. "The EREMA bottle-to-bottle technology is outstanding. We have already used the pellets for bottle-to-fiber and bottle-to-sheet applications in addition to bottle-to-bottle, and the quality has been exceptionally good." The new VACUREMA® will be added to the machinery at the Dantu site from the end of 2025.

### Sharing future goals

In order to realize its future growth plans, Ceville will continue to rely on the cooperation with EREMA, as Bin Huang emphasizes: "Our capacity will increase in the coming years. We want to produce excellent rPET, rHDPE and rPP for our customers, and to achieve this, I intend to further expand our cooperation with EREMA. We are also willing to explore new paths together and consider chemical recycling where mechanical recycling reaches its

limits." Ceville is convinced by the technological leadership of the recycling machine manufacturer, also because they are jointly developing special applications for the Chinese market. "I trust the people at EREMA," Bin Huang continues. "The company's expertise is extraordinary and we have a very good business relationship."

EREMA Group  
Unterfeldstr. 3, 4052 Ansfelden, Austria  
www.erema.com

# Quality Assurance Transformation: *Radar Technology Is Breaking Barriers toward Sustainability and Automation via Wall Thickness Measurements*

*Radar technologies can help blow molders maintain high quality standards and minimize material and energy consumption. The technologies measure geometries such as wall thickness, distance and diameter of suitable parallel walls. In combination with sensor position data, component properties such as contour and ovality can be derived. Parison measurements provide data on process stability at an early stage.*

**R**adar works by emitting electromagnetic waves; when interacting with the plastic walls of a blow-molded product, partially reflected

signals return. These returning signals provide valuable data that can be utilized to accurately determine the thickness of hollow plastic bodies. Since radar technology operates at a non-ionizing frequency of 154 gigahertz, the usage is safe. There are no specific safety requirements dealing with radar.

iNOEX's Warp Gauge sensor and Warp Portable can help offset the skilled-worker shortage and ensure the quality of blow molded parts.

### Warp Gauge Measures Components and the Parison

Working either independently or in combination with a simple kinematic system, radar technology can be used to do fully automatic measure-

ments of blow-molded parts after demolding. Radar sensors are guided perpendicularly to the part surface and, depending on the sensor's measurement frequency and speed of movement through kinematics, a grid of measuring points is created. The sensor measures distance, wall thickness and sometimes the component's diameter. The contour of the component also can be recorded, and conclusions can be made about ovality and distortion. With an accuracy of within 30 microns and a measurement range between 2mm and a maximum that depends on the raw material that is used, the Warp Gauge's real-time monitoring at up to 8 hertz ensures continuous insights. Meanwhile, the sensor's



The Author:  
Peter Koll, iNOEX GmbH

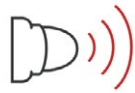

Radar is **contactless** and **non-destructive**



Radar is partially reflected at the interfaces and thus allows **thickness measurement**



Radar radiation is **harmless** and can be used without occupational safety



Radar is almost **temperature-independent** and thus minimises the calibration effort

flexibility allows measurements on finished end products, no matter whether hot or cold. Maintaining precise 90-degree alignment to the plastic surface guarantees reliability. Keeping a distance of 300mm from the sensor to the product provides the best process stability, but the distance can be adjusted if needed.

In addition to measuring parts that have already been demolded, the radar technology can be integrated directly into the blow molding line and provide measurement data during the extrusion of continuously produced cylindrically shaped parisons. More data can be collected over longer cycles.

Due to the small size of the 170mm-by-125mm-by-85mm sensor technology, it can be flexibly integrated into the line depending on the process control and component geometry. Determining whether a particular radar technology is appropriate for the blow molding process depends on the number of data points required to allow conclusions about the process and actively implement process control.

The Warp Gauge sensor is equipped with its own user interface.

No extra hardware is required. Users can access data through a standard web browser. This web-based solution not only ensures user-friendly operation but also allows flexible remote monitoring and control. Users can navigate through different menu sections, including the Current Values menu, which displays real-time data for monitoring ongoing conditions. The Trend menu offers historical data, enabling users to analyze trends over time. The Measurement Signal section showcases the signal strength necessary for sensor alignment, supporting users in optimizing sensor placement. The Recipes section stores product-specific settings in a recipe format, streamlining configurations for various applications. The Alarm List allows users to review alarms if tolerances are exceeded, facilitating timely corrective actions. Additionally, recorded data is available for download into Excel or CSV spreadsheets, enhancing accessibility and analysis capabilities.

Further customization possibilities are unlocked through the utilization of OPC-UA to access the data. By synchronizing measurement and position data with that of a secondary system, such as a robot, a seamless alignment of data becomes achievable. In bringing all these capabilities together, comprehensive information about ovality or distortion can be obtained.

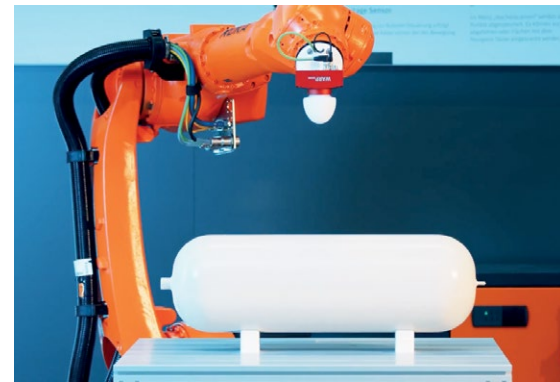
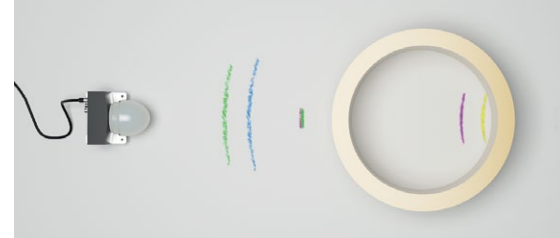

### Warp Portable

The Warp Portable is a mobile, intuitive hand-held measuring device for point-by-point wall thickness measurement. Its integrated centering aid ensures ideal measuring distance. The device takes measurements at the touch of a button. The last 500 measured values, including the measuring angle and time stamp, are logged and can be exported via USB as a CSV file for further usage. The Warp Portable offers a non-destructive alternative to previous measuring technologies that either work destructively

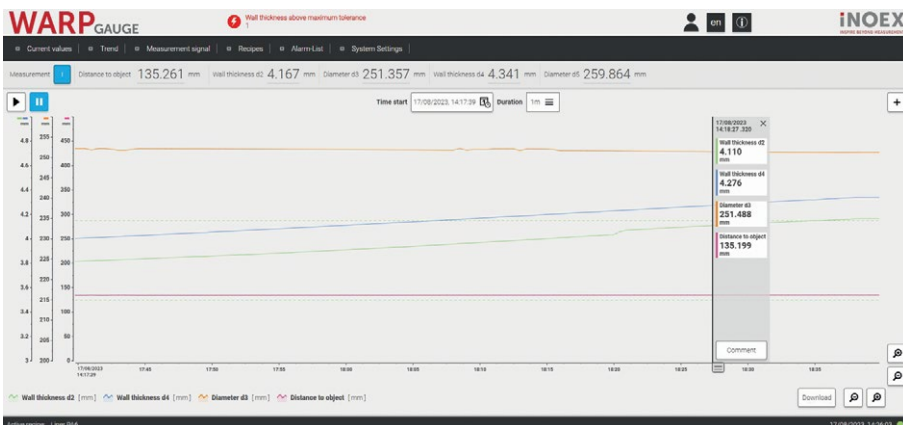



or are complicated and time-consuming with regard to the measuring process.

The Warp Portable is mainly used for starting up the blow molding machine, taking measurements along the line from the bottom to the top of parts and the part circumference and performing hot-off-the-line checks, as well as comprehensive thickness evaluations in the lab.

### Application: Drum

Drums are manufactured in a wide range of sizes and for a multitude of applications. Chemical resistance, dimensional accuracy and mechanical properties, such as stacking pressure resistance and bursting pressure, are important characteristics

for drums. For economic reasons, all these properties should be reliably achieved with minimum material input. Simple kinematics can obtain information about the wall thickness along the height and circumference of the drum.

In addition to wall thickness information, distance data also is recorded to evaluate the shape.

In the case shown here of a 220-liter drum, an unintentionally high wall thickness, especially at the drum edges, was identified. With the use of radar technology, defined tolerances could be continuously monitored and the percentage of plastic that is put into the drum could be reduced. If the wall thickness measured in the middle of the drum is sufficient for the application, more than 10 percent of material could be saved by optimizing. Considering that the edge and L-Ring require a higher amount of plastic, a lower reduction of up to 5 percent in the center of the product is realistic.

One of the most critical parts when producing an L-Ring drum is the L-Ring itself. Doing continuous wall thickness scans below the L-Ring area in a 360-degree-circumference, an observed stable process and sufficient material thickness can signify that the quality of the L-Ring is as expected. Because of temperature independence, other quality tools that are doing a partial wall thickness control along the circumference (e.g. PWDS® at 0 degrees, 90 degrees, 180 degrees and 280 degrees) can be adjusted in iterative steps without waiting for the parts being measured to cool.

Spot checks via manual radar measurements provide data to adjust machine settings directly after startup.

### Application: Hydrogen Pressure Vessel

Particularly for mobile applications such as vehicles or mobile storage modules, Type IV composite pressure vessels are up to 70 percent lighter than steel fuel tank cylinders. The liner plays a central role here: It forms the actual pressure vessel, provides a hydrogen permeation barrier and is responsible for the tightness of the container, which provides up to 700 bar of operating pressure. The liner is subject to the strictest quality requirements and ensures the safety, efficiency and durability of the vessel. Radar technology ensures the liner quality. In the cylindrical area, wall thickness, diameter and eccentricity can be determined; in the dome area, the contour, wall thickness and deviations from the target geometry can be determined.

### Case Study: Robotics as Kinematic Element

Robotics can be used as a handling tool for radar measurement technology. Lab testing with a collaborative robot (cobot) measuring parts of a hydrogen pressure liner illustrate the suitability when it comes to required accuracy.

In measuring the blow molded liner of a particular pressure vessel, the positioning of the robot when focus-

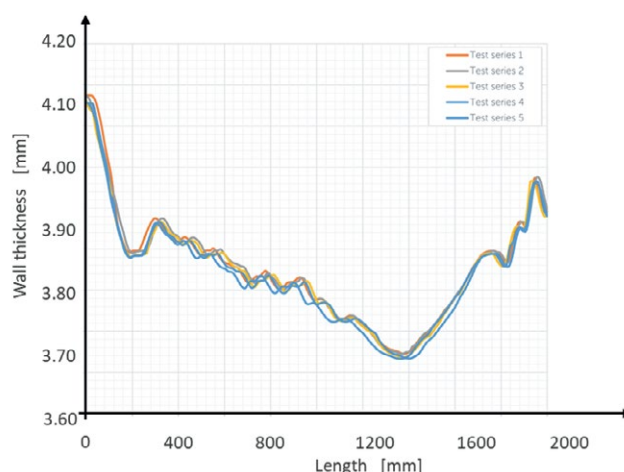
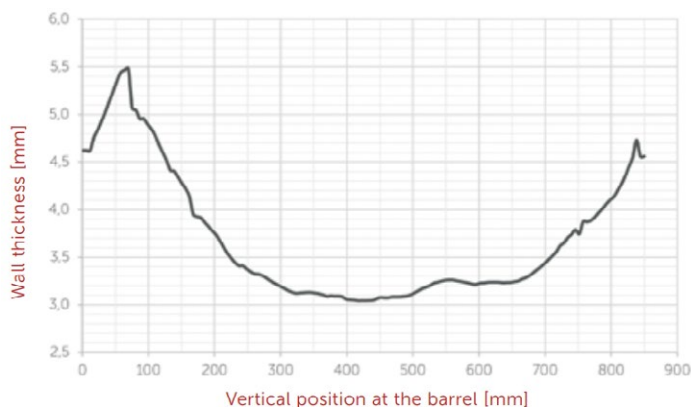



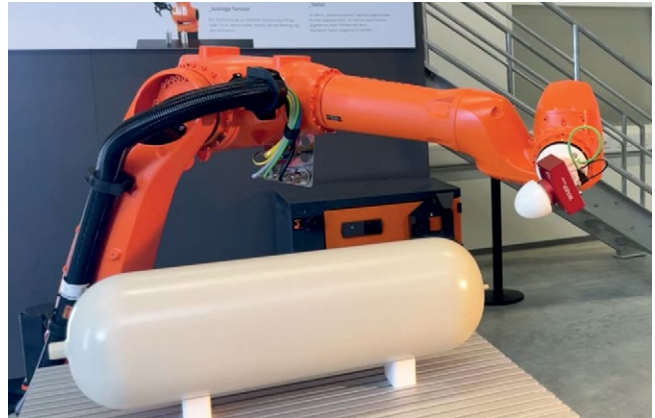
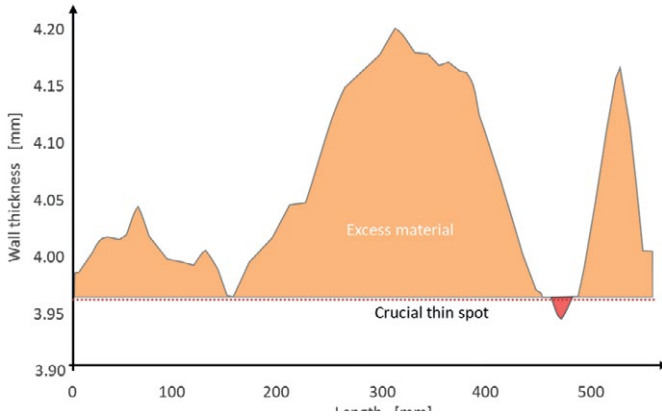

ing on a single point allowed sensor measurements with an accuracy of within 0.00046mm; the accuracy when sample positioning of within 0.0045mm reflected the ability to place the liner consistently and precisely. In dynamic scanning scenarios, where the robot performs linescans, the system maintains a level of repeatability of within 0.0084mm, crucial for capturing detailed measurements during movements.

Taking into account positioning thresholds for the measurement itself, an angle deviation within 5 degrees still ensures continuous results. The absolute position of the workspace is more flexible and can be varied in a range of within 10mm.

Compared with cobots, industrial robots used in inline applications are even more accurate.

**Benefits of Using Radar Technology**

Compared to other technologies, radar technology provides users with a number of advantages:

*Quality improvement:* Constantly increasing demands on component quality, process efficiency and the documentation of process and quality data make it necessary to reduce manual quality assurance processes and to push digitalization. The high precision and extreme robustness of radar-based measurement technology make a decisive contribution to this, as components can be measured automatically and without a significant amount of manpower.

*Data quantity:* Radar technology increases the amount of data that can be measured, either manu-

ally or automatically, over a certain amount of time.

*Plug-and-play operation:* The inline-capable Warp Gauge radar solution is suitable to be used as a browser-based system, with an integrated user interface to visualize measurement results. Alternatively, measurement data can be read out via an OPC-UA interface, processed and combined with other data. This simplifies integration and makes the measuring system flexible without any additional hardware.

*Transparency:* Radar technology measures geometries such as wall thickness, distance and diameter of suitable parallel walls. In combination with the sensor position data, further component properties such as contour and ovality are derived. Since the Warp Gauge can perform several measurements per second, a comprehensive picture of the components is created and local deviations are identified. The measuring accuracy and reproducibility of the technology is in the range of a few hundredths of a millimeter.

*Thin spot detection:* In addition to performing visual inspection, weight checks and pressure tests, radar detects thin spots in critical areas. With radar measurements, users can determine if observed thickness distribution meets or exceeds given tolerances. Given more time, more areas can be measured.

*Material savings:* An unevenly distributed wall thickness increases cooling time and reduces productivity. Homogeneous wall thickness

distribution saves energy and makes it possible to use up to 5 percent less material.

*Process control:* Access to measurements derived from data allows the system to react immediately to batch fluctuations or drifts in the process. The importance of manual component checks and employees' process knowledge is reduced.

**Integration of Radar Technology**

To estimate the potential savings radar technology can offer for a specific blow molding process, it is essential to conduct an analysis of the current situation. This analysis involves evaluating various factors such as the current quality assurance methodology, the effort required, component variability, the number of measurement points, cycle time and level of automation. Radar measurements conducted in a laboratory setting with the assistance of robotics can help determine the quality and quantity of data that can be obtained, thus facilitating an ROI calculation. Both iNOEX and the blow molding machine OEM can provide recommendations or offer individualized designs for assisting kinematics, taking into account the complexity of the components and their measurement tasks.

Additionally, a radar solution integration partner, such as the OEM, can play a fundamental role in developing control loops or implementing AI-based machine learning algorithms.

# Risk-free Process Optimization – *Testing System Precisely Meters Different Blowing Agents Even with Fluctuating Extruder Pressure*

*A lower density, better mechanical and insulating properties and significantly reduced raw material consumption. Given these advantages, it is no wonder that foamed plastics have taken the market by storm in recent years. They are mainly used as packaging components and for shock absorption, thermal insulation and soundproofing. However, the variance in blowing agents and their process conditions, such as high pressure or deviating temperatures, require specified systems and quickly make the extrusion process relatively complex. The LEWA ecofoam metering system provides a remedy. A fail-safe complete solution for all known blowing agents, it is characterized by consistently precise metering even for fluctuating parameters.*

The LEWA ecofoam testing system offers users a cost-efficient opportunity to see the reliable quality of the extruder system and the end products for themselves in everyday operation without obligation.

*With the LEWA ecofoam metering system, the Leonberg pump manufacturer offers a fail-safe complete solution for all known blowing agents. It is characterized by consistently precise metering even for fluctuating parameters.  
(Pictures: LEWA)*



Depending on the intended use and desired properties of the plastic product, different blowing agents are used in foam extrusion. For example, they can be carbon dioxide, propane, butane, pentane or halogenated hydrocarbons such as Freon 152a. Although the discharge pressures and temperatures of these media differ from one another, the metering of the blowing agent into the plastic melt must be consistently precise in order to achieve a homogeneous and high-quality end product. The proven LEWA ecofoam metering system was therefore specially designed to meter all common blowing agents precisely and reliably.

## **Universal extruder system for testing with all blowing agents**

To ensure the required constant foam quality, the quantity of blowing agent in the LEWA ecofoam is adjusted proportionally to the rotation speed of the extruder. The smart control technology developed by LEWA itself comes into play here. It continuously compares the signal from the flow meter with the guide signal and regulates the rotation speed of the drive motor accord-

ingly. Due to the pump's pressure-stiff characteristic curve, metering remains constant even for fluctuating extruder pressure.

At its core, the hermetically tight and therefore low-maintenance system consists of a LEWA ecoflow

*The LEWA ecofoam testing system offers users a cost-efficient opportunity to see the reliable quality of the extruder system and the end products for themselves in everyday operation without obligation*

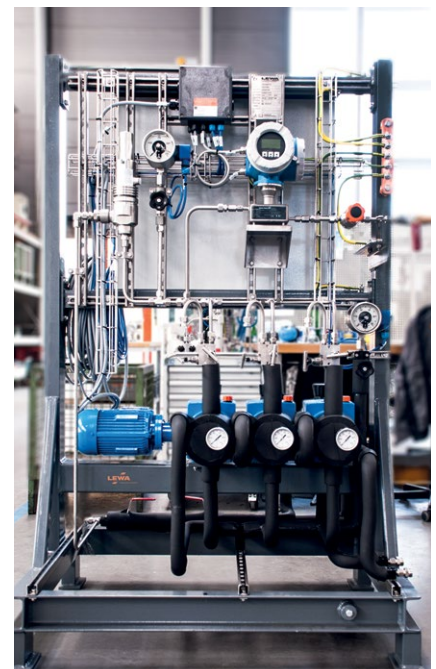

diaphragm metering pump, which delivers the blowing agent at a pressure of 50 to 350 bar. The flow rate depends on the set pressure and the compressibility of the medium. For example, it can be 13 kg/h CO<sub>2</sub>, 8 kg/h i-butane or 20 kg/h H<sub>2</sub>O at 250 bar. Since the LEWA ecofoam testing system was designed for all known blowing agents, it is already explosion-proof for flammable me-

dia such as propane or butane as standard and is equipped with a cooling unit for carbon dioxide.

To ensure that the system can be easily transported for testing purposes, all components are securely mounted on a common mount base. It can be rented for up to six weeks without obligation, although longer periods are also possible by arrangement. This gives users the

opportunity to test the reliable quality of the system and the consistently precise metering of different blowing agents in a real application environment – entirely without financial risk.

**LEWA GmbH**  
 Ulmer Str. 10, 71229 Leonberg, Germany  
 → [www.lewa.com/en-US/systems/lewa-ecofoam](http://www.lewa.com/en-US/systems/lewa-ecofoam)

# Cutting Rotor KRONOS-MAX in the Spotlight

*For 60 years, H. Schoenenberger GmbH has been a name synonymous with the manufacture of high-quality premium knives. The development of new, innovative products is a core competency of Schoenenberger. In the field of plastics, the company focuses not only on products for the recycling industry but also on cutting rotors for strand pelletizer. At the forefront is the unique KRONOS-Max.*

Technologically, the KRONOS cutter rotor is now considered a benchmark in professional circles, living up to its name derived from Greek mythology. "This innovation is globally unique. KRONOS is based on the combination of the wedge-shaped cutting blade made of carbide with the steel cutting rotor body. The robust cutting blades (knives) are securely and form-fit inserted into the precisely machined mounting grooves without additional clamping elements or screws. This creates an extremely resilient cutting rotor, which is essential for achieving precise cutting results for poly-

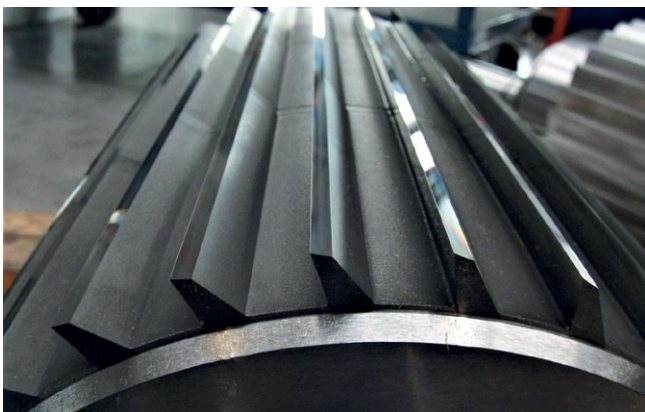
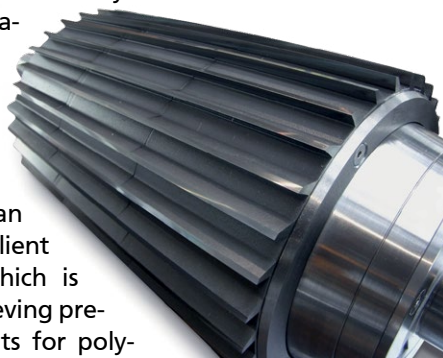

mer strands and ensuring a long service life," explains Andreas Suess, Product Manager at Schoenenberger, describing the innovative design principle.

The "Max Coating" combines two innovations to create an exceptional product. The special carbide coating, which we call Max, offers maximum wear resistance. The coating medium is applied to the surface of the steel cutting rotor body at very high speed, forming a diffusion bond. This process makes the cutting rotor extremely wear-resistant and also prevents coating from flaking off. We are proud to offer our customers such an outstanding product for all common granulation systems, and the great positive feedback, especially from China, confirms our quality and expertise, says Product Manager Suess.

**H. Schönenberger GmbH**  
 Ploching Str. 36, 73779 Deizisau, Germany  
 → [www.schoenenberger-messer.de](http://www.schoenenberger-messer.de)

# "Monitoring the Manufacturing Process Helps Us to Significantly Reduce Scrap"

*Uponor relies on inline millimeter wave technology from SIKORA for the measurement of plastic pipes: Uponor Corporation was founded in 1918 and is nowadays based in Helsinki, Finland; since November 2023, the company has been part of Georg Fischer AG. Uponor offers its customers sustainable building and infrastructure solutions within its three business segments: Building Solutions – Europe, Building Solutions – North America and Uponor Infra. Today, Uponor employs more than 4,000 professionals in 26 countries in Europe, North America, and Southeast Asia. At the production site Vaasa, Uponor Infra Oy uses SIKORA's CENTERWAVE 6000 to continuously monitor the quality of its plastic pipes during extrusion.*

Continuous monitoring during manufacturing is not only requested by Uponor's customers, but also necessary to receive the best product quality and to optimize production processes. Therefore, Uponor Infra Oy uses the CENTERWAVE 6000/1200 for measuring its drinking water pipes, pipes for wastewater applications, radiant heating and cooling systems, jacketing pipes and industry pipes. The measuring system, based on millimeter waves, is suitable for pipes from 450 to 1,200 mm diameter. "When we were looking for a suitable measuring device for our extrusion line, we compared different systems on the market," says Anders Beijar, Production Manager at Uponor Infra Oy. "At different production sites, we tested both a system with fixed sensors and the CENTERWAVE, which has a rotating sensor instead. The fixed sensors did not cover the whole pipe, whereas we were able to measure the complete circumference of the pipe with the CENTERWAVE – gapless! This measuring principle convinced us at once," further explains Beijar.

Installed early in the process, the CENTERWAVE 6000 measures the wall thickness and pipe diameter directly after the first vacuum tank. This lays the foundation for material savings. "The start-up of CENTERWAVE 6000 is easy, you just switch it on and it starts working fast and reliably. You do not waste any time for presetting etc. The immediate monitoring of the manufacturing process helps us to significantly reduce scrap," says Beijar. In times of increasing raw material prices and material shortage, material savings are essential for Uponor Infra Oy. "Scrap can be used for producing pipes again; however, if you produce a pipe overweight, it is delivered to the customer and cannot be used again. You simply do not get it back. Our pipes weight from 50 to 350 kilos per meter and raw material is expensive. Thanks to the CENTERWAVE 6000, we can produce closer to the tolerances in a sustainable way by manufacturing economically and saving scarce resources at the same time."



*Anders Beijar, Production Manager at Uponor Infra Oy, with the CENTERWAVE 6000 from SIKORA*

The investment in the CENTERWAVE quickly paid off for Uponor Infra Oy. "We had a special project where the CENTERWAVE was running about a year. Here, we saw a lot of savings so that our investment paid off within just a few months," resumes Beijar. Uponor is also satisfied with the service provided by SIKORA. "The communication with the SIKORA Service during installation and support afterwards was good. We are very pleased with SIKORA's quick and reliable ongoing support," states Beijar.

**SIKORA AG**  
Bruchweide 2, 28307 Bremen, Germany  
➔ [www.sikora.net](http://www.sikora.net)

**Uponor Corporation**  
Ilmalantori 4, 00240 Helsinki, Finland  
➔ [www.uponorgroup.com](http://www.uponorgroup.com)

# EXTRUSION

EXPERT MAGAZINE ON PLASTICS EXTRUSION

The only technical magazine worldwide exclusively for the sectors:

- Material Preparation
- Compounding
- Extrusion
- Recycling
- Calendering
- Thermoforming
- Welding
- Finishing of Plastics and Elastomers



**Extrusion** (German)

**Extrusion International** (English)

**Extrusion International USA** (English)

**Extrusion Asia Edition** (Mandarin/English)

The only plastics trade magazine for Asia, published from Germany

8 issues a year

6 issues a year

6 issues a year

2 issues a year

**SMART  
EXTRUSION**

All editions available for free:

[www.smart-extrusion.com](http://www.smart-extrusion.com)

**VVA** Verlag GmbH Cologne/Germany



# Use of Recyclates in Food Contact-Method Development for the Validation of Plasma-Induced Barriers

*Due to the increasing use of plastics in recent years, the demand for recycling processes has grown in order to reintroduce plastics into the circular economy after their application. The ultimate goal of a recycling process is the consistency of the quality of the recycled plastics comparable to the original product. In addition to many physical and chemical properties, such as the chain length and the rheological behavior of the polymer, the fluctuating contamination of a recycled plastic limits the corresponding field of application. Especially property changes of toxicity and odorous smell reduce the use of recyclates of all art.*

A. Cetin, R. Dahlmann  
Institute for Plastics Processing  
(IKV) in Industry and Craft at RWTH  
Aachen University

Recycled streams of everyday plastics contain residual impurities, making them unsuitable for use as food contact materials. In order to assess and limit the safety and potential hazards of possible contaminants in recyclates, the applicability of recyclates and recycle technologies are specified by European regulations and authorities. In order to enable recycling streams of plastics after the application phase in everyday use as food contact materials in the form of recycled plastic food packaging, different strategies are applied. One possible strategy to this problem is barrier development of a glassy layer on recyclates using plasma enhanced chemical vapor deposition (PECVD), which can potentially prevent migration of contaminants through barriers. To evaluate impurities and their migration from recycled plastics and possible barrier effects of the PECVD layers, a novel contamination approach for virgin materials is introduced. Further, an analysis chain regarding migration evaluation by gas chromatography coupled mass spectrometry (GC/MS)

and a starting point for barrier developments are discussed.

## Circular economy of plastics

In the last decades ideological changes of industrial approaches resulted in a higher demand of ecological thinking [Pfa22, VPA+22, YLC+21]. One particular aspect regarding plastics is the integration of plastic waste as a valuable pier for futures products due to their exponential consumer growth [Ber22, GPSB23]. Packaging plastics hold the largest stake in the distribution of the worlds global plastics application by 44%. Further comparing the distribution of plastic types Polypropylene (PP) accounts for an overall 19.3%. Despite many measures of

governmental sides to increase the share of recycled plastics, only 8.3% of worlds plastics production were post-consumer recycled plastics in 2021 (see **Picture 1**) [PLA22].

In Europe a set goal for a plastics strategy is conducted to meet net zero for plastics by a carbon neutral and fully circular economy [PLA22, FW22]. The aspects of circular thinking will determine the lifecycle of future products in terms of recycling, durability and reuse [Pfa22, GPSB23, FW22]. The post-consumer history and material stream of plastics direct their recycling trough energy recovery, chemical or mechanical

Picture 1: World plastic origins and global distributions

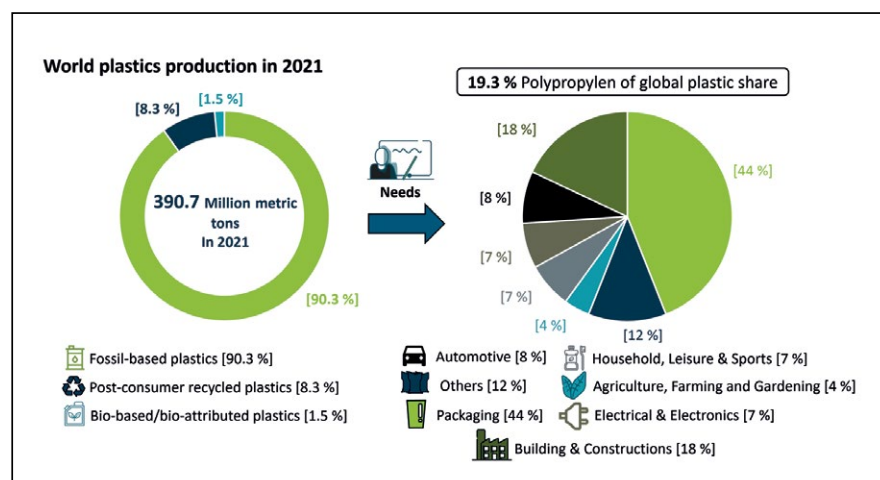

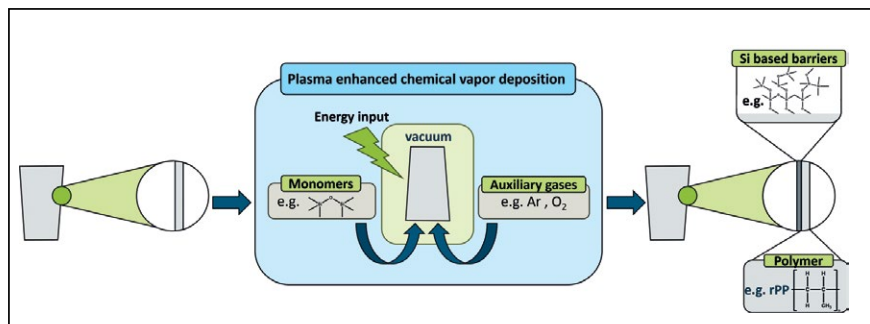

Picture 2: Concept of plasma enhanced chemical vapor deposition

recycling. Ecologically and energetically, mechanical recycling is favorable under the circumstances of pure material streams. Including the disadvantages of increased sorting and purification efforts. The idea of mechanical recycling is the replacement of virgin pristine materials by recyclates of constant quality. However, this is challenging in case of recycled post-consumer waste plastics since unknown impurities and miscibility's of different type of polymers effect the resulting quality of the recyclates and limit their applications [SS21, FW22].

### Recyclates in food packaging

Since packaging plastics account for the largest share of global plastic production, the resulting rapid generation of plastic waste and mismanagement cause environmental damage to ecosystems and humanity. Hence, rapid mechanical recycling for post-consumer packaging plastics and the use of recycled plastic in this sector is indispensable [SS21]. From a contamination perspective, the use of post-consumer plastics in food applications is a critical issue where safety assessments and analytical methods must be coordinated to exclude human harm, since remaining contaminations can migrate into food. The impurities can be distinguished in their origins and end up in many variations in post-consumer recyclates (PCR) [UGPv23, FW22]. Under the aspects of life cycles of post-consumer plastic, these contaminations originate from different polymeric impurities, additives, chemical contaminants resulting from intended and unintended use, chemically formed

substance during recycling process and degradations of plastic compositions [RDv17, STB+23, FW22]. For the identification of these, various techniques are suitable to detect compounds of different origins for example GC/MS related to volatile monomers [STB+23, WF08, WF11].

Before the implementation of recycled post-consumer plastics as packaging applications, the identified amounts of impurities by their migrations need to meet several requirements since the applications are restricted to the quantity of migrating contaminants. These limitations are set by different organizations like the U. S. Food and Drug Administration (FDA) or the European Food and Safety Authority (EFSA) according to the application regions [EU 11, EU 23, EU 22, Foo21]. In Europe, final products originating from recycled plastics need to meet the threshold of toxicological concerns and complex mixture safety assessments related to their product sections especially for the Food Contact Materials [EU 11, EU 23, EU 22]. Therefore, intensive research for the analysis, identification and reduction of contaminations in plastics are conducted to design their life cycles [BJ23, UGPv23, Pfa22, STB+23]. Including, modelling of migration and design of different recycling paths [RDv17, Fra05, WF08]. Even though, recycling processes developed in recent years, the recycled post-consumer polypropylene stream for packaging materials don't meet overall quality for safe use especially in the food packaging industries whilst holding the overall largest plastic share [PWNC22]. One way to enable the use of PCR polypropylene in the Food Contact Material sector is to overcome the migration of impurities by an efficient barrier protection.

### Plasma barriers for food contact materials

A promising path to protect materials against contaminations, degradation and migration during food contact or other inorganic and organic substances is a surface coating via plasma enhanced chemical vapor deposition (see Picture 2) [SHT+23, WF11].

Plasma based coatings enable evading the limitations of gas permeation of packaging materials [Pre10]. Transferring the methodology to food containers based on recycled plastics, an alternate approach to stop migrations of contaminants can be achieved in comparison to other e.g. multilayered plastic composite films [KBD22, WF11]. Including the advantages of low operating and material costs with homogenous properties compared to other barrier approaches. Gaseous monomers are excited by electromagnetic radiation to the plasma state leading to their fragmentations in the PECVD processes. Subsequently, plasma polymerizations result in recombination by a layer deposition of the plasma onto corresponding substrate surfaces [YLC+21]. Through a simple process control during PECVD, nanoscale functional coatings with a fast deposition rate, outstanding chemical and physical film properties on low temperature substrates can be achieved. Process parameters such as monomer input, gas flows, energy display influence the resulting chemical and physical film properties e.g. chemical structure and layer thickness [AAB+23]. Significant influence on the resulting surface properties can be assigned to the power input and power pulsing, influencing the fragmentation and the resulting plasma polymerisation during PECVD process [KBD22]. Among various coating chemistries silicon-based coatings gained high relevance due to their excellent properties and efficient processability in industry [CLW01]. Silicon oxide (SiO<sub>x</sub>) barrier coatings with various chemical and physical properties can be quickly, nondestructively and environmentally friendly deposited [VPA+22]. SiO<sub>x</sub> coatings

possess efficient barrier functionalities, leading to their widely distribution in packaging industry as gas barriers, reducing the permeations from packaging [CLW01]. Based on layer structures e.g. cross-linkage, porosity and optical transparencies various macroscopic properties with permitting permeation of differing molecules can be achieved [AAB+23]. In order to deposit SiO<sub>x</sub> barriers with efficient barrier properties a high fragmentation is desired according to literature [AAB+23]. A higher fragmentation can be initiated by a higher oxygen environment in combination to high energy input [KBD22]. Resulting nanoscale SiO<sub>x</sub> layers are attributed to hard, highly crosslinked and brittle glassy structured efficient gas barriers containing low organic content with smooth low ductile surfaces [JHB+17, VPA+22]. Further, nanoscale PECVD coatings on plastics can be introduced into existing recycling processes without any negative influences [VPA+22]. Transferring the idea of gas permeation barriers to migration barriers applied to PCR, a migration limitation of hazardous contaminations could be potentially carried out by SiO<sub>x</sub> coatings (see Picture 3) [KBD22, WF11].

### Generation of model-recyclates for barrier development

Prior to initiating the development of effective barrier layers, it is imperative to consider post-consumer recyclates sourced from various disposals, recycling strategies and environmental factors [KBD22, PWNC22]. The dynamic life cycle factors of recyclates inherit variations in chemical compositions and physical properties, resulting in an inhomogeneous products stream

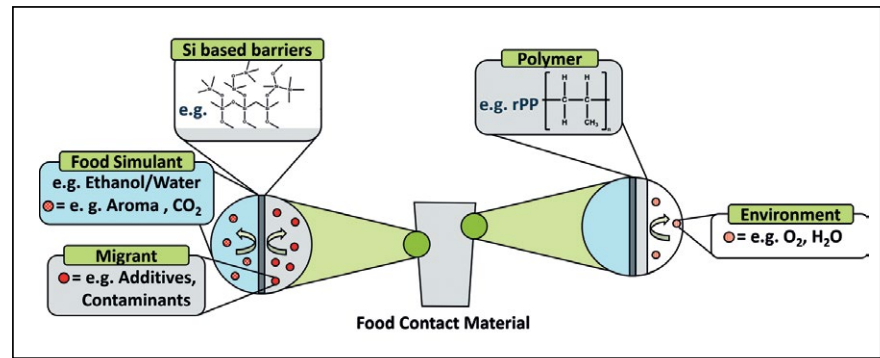

Picture 3: PECVD coatings as potential migration barriers

quality and challenges in barrier development [Pfa22, KBD22]. Considering differences not only in terms of a contamination perspective but also regarding the processing of post-consumer materials, as well as their applications, especially within the realm of food-related sectors, is associated with limitations [PWNC22, RDv17, Ber22]. Taking the contaminations in a complex matrix respectively to the physical and chemical properties of the recycled post-consumer plastics into account, the quantification and qualification of the migration behaviour of contaminants in those matrices is necessary. Therefore, not only the barrier development is from urgent need but also the implantation of an analysis chain to determine the efficiency of these barriers and meeting the desired migration requirements (see Picture 4) [YLC+21, FHP94].

To reduce the complexity and accelerate barrier development, virgin materials can be contaminated with determined chemicals prior for barrier evaluation. The barrier evaluation contains the introduction of the contaminants into virgin plastics, followed by barrier developments, migration testing and analysis. The migration testing procedures and analysis are determined by official regulations in relation to the specific application fields. Prior

for barrierdevelopments the analysis is designed appropriate to the introduced chemicals. This general process is similar to the evaluation of recycling processes based on the regulation of the FDA or EFSA, where so-called challenge test chemicals are introduced into pristine plastics to evaluate their decontamination during recycling [Foo21, EU 22].

Insufficient quality and immense application potential for food packaging of post-consumer polypropylene are the key motivation points of the research at the IKV to address and overcome challenges associated by contamination, hereby implementing effective migration barriers especially to reintegrate post-consumer polypropylene [Sytalen PP-C14900 gr000] to the circular economy.

### Challenges in development of functional barriers on recyclates

Beneath the challenges of migration analysis to corresponding SiO<sub>x</sub> plasma barriers, a fundamental understanding to the plasma deposition on virgin and recycled con-

Picture 4: Proposed migration evaluation process for barrier developments

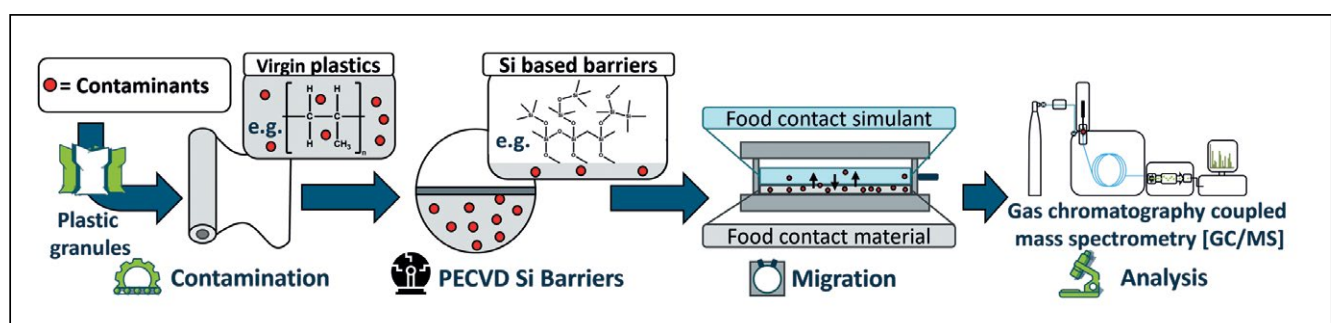



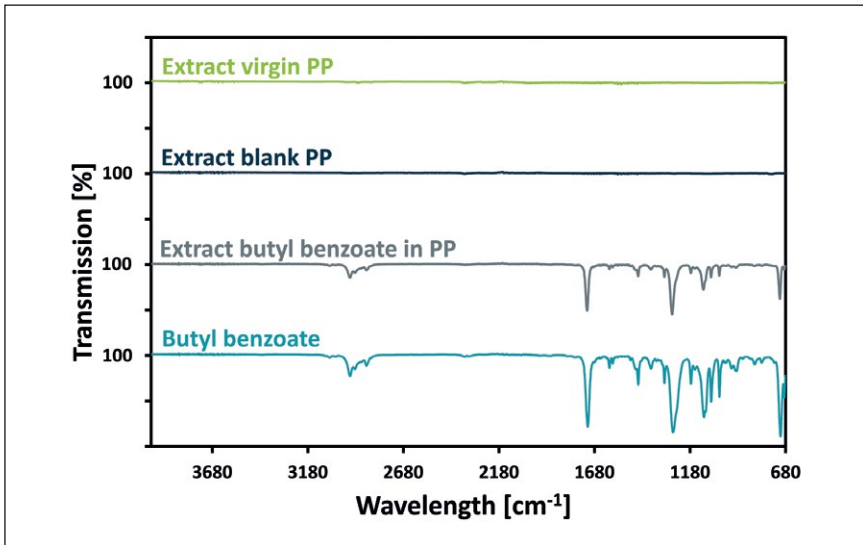

Picture 5: Infrared spectra of extracts in DCM from virgin PP, blank PP and butyl benzoate in PP and of pure butyl benzoate

sumer plastic is of urgent need. Only through control of plasma processes a sufficient barrier can be applied on various surfaces [KBD22, AAB+23, PWNC22]. Including different barrier characteristics in relation to changing material surface properties to enable migration barriers [KBD22, AAB+23, SHT+23].

To address the challenges of barrier deposition on varying surface qualities of recycled materials, due to impurities, differing roughnesses and molecular distributions a multilayer coating approach is considered. The decoupling of SiO<sub>x</sub> barrier efficiency from deposition on surfaces with varying properties is important, since the barrier properties are coupled to the deposition quality [KBD22, VPA+22, JHB+17]. Previous study has been conducted to overcome the challenges by the use of an organosilicon (SiOCH) intermediate coatings to decouple the properties of SiO<sub>x</sub> barrier coatings from the varying above mentioned surface properties of the underlying substrates [KBD22]. Organic SiOCH layers containing high organic carbon amount are considered to be weakly crosslinked, elastic, ductile and relatively soft barriers with low permeability and high surface roughness, enabling them to act as optimal intermediate layers [KBD22, VPA+22]. Hence, the SiOCH layer acts as a surface promoter and stress reliever for

the brittle SiO<sub>x</sub> layer deposition since the SiOCH layer can be designed prior to efficient SiO<sub>x</sub> deposition and decouple the challenges of direct SiO<sub>x</sub> deposition on the corresponding substrate [VPA+22, JHB+17]. For the SiOCH layer deposition the same monomer as for the SiO<sub>x</sub> under differing lower to none oxygen input is applied [KBD22, JHB+17]. Further, a low fragmentation is desired to deposit a high organic content composition. Therefore, low energy input is required proper to lower monomer defragmentation [KBD22, VPA+22]. The applied SiOCH interlayer promotes the adhesion and decouples the resulting barrier properties for SiO<sub>x</sub> of the applied barrier composite to the surface [VPA+22, JHB+17, KBD22]. Further having a lower energy input in combination to lower oxygen contents for SiOCH coatings as compared to SiO<sub>x</sub> coatings,

etching processes of the substrate surfaces can be inhibited to protect weakly structured substrate surfaces [AAB+23, KBD22, CLW01]. Additionally, dyad barrier systems consisting of SiO<sub>x</sub> with SiOCH interlayers were conducted, relieving the layer stresses without reaching the critical layer thickness to increase the total thickness of SiO<sub>x</sub> barriers and further improving the barrier properties [KBD22]. The previous conducted multilayer coating study in combination to the novel contamination approach and proposed characterization chain will be the basis for the barrier developments and evaluation of migration mechanisms.

### Results from a novel contamination approach

FDA or EFSA guidelines require an introduction of model contaminants in which the virgin plastics are stored under certain environmental conditions with the contamination surrogates and then purified before testing [Foo21, EU 22]. A novel contamination approach of PP at the IKV is conducted by a direct introduction of the contaminants in virgin polypropylene [Moplen HP640J] samples. Due to this novel approach, a higher concentration of certain suitable contaminants can be efficiently achieved. For an effective barrier evaluation on PP various chemicals based on volatility and polarity re-

Picture 6: Thermogravimetric and derivative thermogravimetric curves of virgin PP, blank PP and butyl benzoate in PP

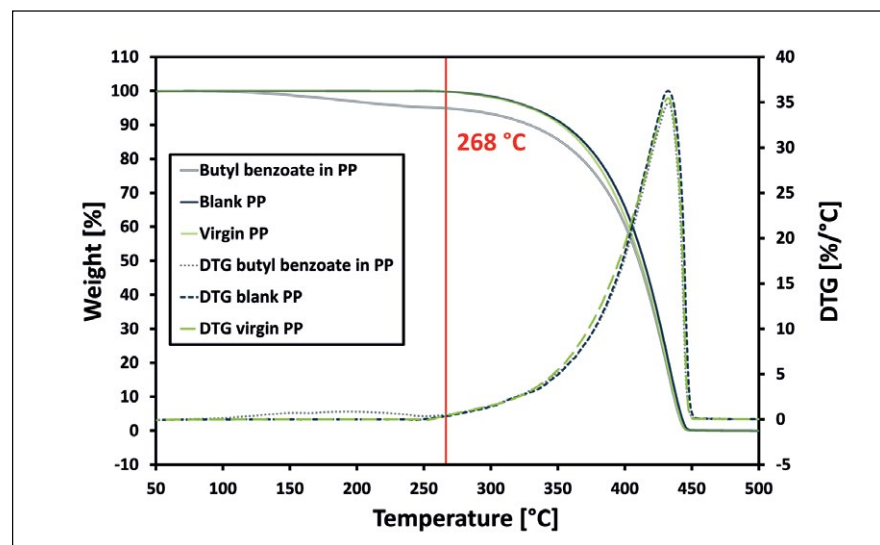

garding to their applications e.g. additives were introduced. Through, a broad spectrum of contaminants, migration mechanisms and effects can be investigated related to the barriers and the plastic itself. The evaluation of the contamination procedure will be covered with several analytical techniques in terms of qualification, quantification and effects of the model substrates on PP properties to enable the concept of an efficient contamination procedure, migration evaluation and thus barrier developments. The successful introduction of one of the predetermined model substrates into PP can be qualitatively observed in the Infrared spectra of the corresponding extracts of the samples (see **Picture 5**).

Respectively for the differentiation of virgin and blank PP, blank PP is the processed version through compounder without adding any chemical. Seeing no absorption for the extracts of the virgin and blank PP respectively to the corresponding absorption bands of the extract from the compounded butyl benzoate in PP, a successful qualitative contamination can be observed by comparing the visible absorption bands to the originating absorption bands of pure butyl benzoate. A quantitative validation for the contamination procedure can be observed demonstratively in the thermogravimetric analysis (TGA) results for one of the model substrate butyl benzoate in PP in comparison to blank and virgin PP samples (see **Picture 6**).

A decrease of the weight percentage and peaks of derivate thermogravimetry (DTG) curves of all samples can be seen at 430°C until 440°C, indicating a complete degradation of all samples. The weight percentage and DTG curve of the butyl benzoate in PP shows a deviation to the other samples below 268°C. Since the boiling point of butyl benzoate is 250°C the decrease before 268°C can be attributed to the evaporation of the butyl benzoate proving a successful introduction in PP. After complete evaporation at 268°C indicated by the merging DTG curves of all PP

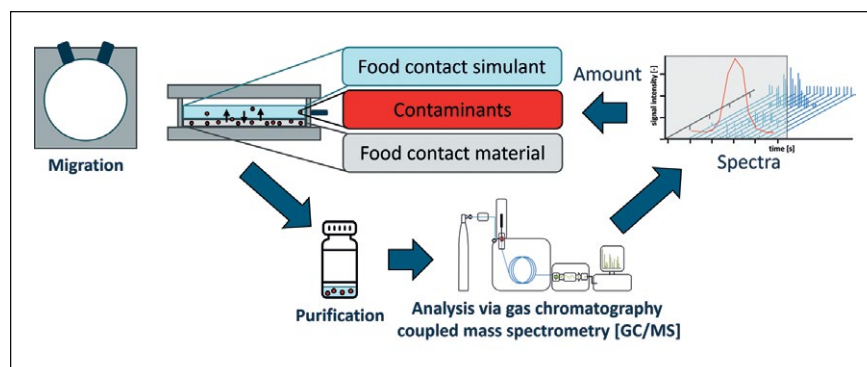

Picture 7: Quantitative and qualitative migration analysis via GC/MS

samples only the remaining PPs are degrading. Therefore, the difference of the weight curves of the PP samples at 268°C can be assigned to the weight of evaporated butyl benzoate which is around 5 percent. The resulting smaller contamination amount than the desired 10 weight percent could be explained through evaporation during the contamination procedure, uneven distribution of the model substrates in the granules and evaporation during storage through migration.

### Migration analysis

Under the aspects of an efficient barrier development, a respective barrier evaluation by a valid analysis chain is essential to understand the migration mechanisms of contaminants in the polymer, plasma barrier and food matrixes [FHP94, KBD22]. Regarding the barrier migration characterisation, a methodology needs to be introduced to assure a targeted analysis of all introduced model substrates after migration processes. The methodology needs to be in accordance to the regulatory authorities in order to ensure the future applicability and authorization of the proven barriers [EU 11, EU 23, EU 22, Foo21]. The EU and EFSA regulations determine the scope of food contact plastics in terms of application, applicable functional barriers and both of their testing procedures regarding overall migration limits and specific migration limits for a broad spectrum of substances [Pfa22, EU 11, EU 23, EU 22]. According to the food contact testing, the experiments need to be performed through a contact to a specific food simulant [OLH+21, SWB07, RBS09]. Including, certain testing procedures related

to sample preparation and contact conditions [RBS09]. By the quantitative and qualitative analysis regarding the migrated substances to the food simulant, the accordance to the migration limits is determined and an approval procedure for a certain food contact material can be induced [EU 11, EU 23, EU 22].

After the novel contamination procedure to introduce the model substrates to the corresponding polypropylene samples followed by barrier deposition, a migration testing including a purification and characterization of the surrogate mixture in the food simulant by gas chromatography coupled mass spectrometry (GC/MS) is supposed to be suitable to quantify and qualify the migrated substances and enable a barrier development (see **Picture 7** and **Picture 4**).

Achieving a basic understanding of migration mechanisms inside the polymer matrix, the plasma barrier structure and at the interface to the barrier layer is from high relevance to modify coating properties and to inhibit migration processes [PWNC22]. Therefore, all interacting layers will be characterized in terms of physical and chemical properties to display interactions corresponding to the migration behaviors of the model substrates inside the material matrixes as a basis for the barrier development. To ensure the previous mentioned understanding of mechanisms and development of plasma-based barriers, the migration needs to be analyzed. Besides, enabling the transfer of the model approach results to recycled consumer plastics.

## Conclusion and outlook

A novel contamination approach has been conducted to efficiently perform barrier developments. The implemented method was designed in accordance to European and American regulations for migration assessment in barrier developments or recycling processes to provide an additional path of simplified approvals. In Virgin PP, a higher concentration was achieved, setting the basis for an efficient barrier development by reducing the challenges

in a proposed analysis chain for the simplified evaluation of migration processes. The next step is the validation of the analysis chain before an efficient barrier development can be performed based on the previous results. The final step is to transfer the methodology to recyclates after successfully permitting migrations of the model substrates and enabling the path for the development of barriers on recyclates for food contact materials by achieving specific migration limits.

## Acknowledgements

This research was funded by the Deutsche Forschungsgemeinschaft (DFG, German Research Foundation) under the Sonderforschungsbereich Transregio 87 (SFB TR-87). We would like to cordially extend our thanks to the DFG. Additionally we would like to thank Professor Grundmeier and his team from Universität Paderborn and our partners GIZEH Verpackungen GmbH & Co. KG, DSD – Duales System Holding GmbH & Co. KG.

## References

- [AAB+23] Arcos, T. D. L.; Awakowicz, P.; Böke, M.; Boysen, N.; Brinkmann, R. P.; Dahlmann, R.; Devi, A.; Ermin, D.; Franke, J.; Gergs, T.; Jenderny, J.; Kemaneci, E.; Kühne, T. D.; Kusmierz, S.; Mussenbrock, T.; Rubner, J.; Trieschmann, J.; Wessling, M.; Xie, X.; Zanders, D.; Zysk, F.; Grundmeier, G.: PECVD and PEALD on polymer substrates (Part II): Understanding and tuning of barrier and membrane properties of thin films (26.06.2023), P. 2306.14797v1
- [Ber22] Berg, H.: Overcoming Information Asymmetry in the Plastics Value Chain with Digital Product Passports. Wuppertal Paper 197 (2022), p. 1-28
- [BJ23] Bayer, F. L.; Jetten, J.: Safety assessment of refillable and recycled plastics packaging for food use. In: Knowles, M.E.; Anelich, L.; Boobis, A.; Popping, B. (Editor): Present Knowledge in Food Safety. Elsevier, 2023
- [CLW01] Czeremuszkin, G.; Latreche, M.; Wertheimer, M. R.: Ultrathin Silicon-Compound Barrier Coatings for Polymeric Packaging Materials: An Industrial Perspective. *Plasmas and Polymers* 6 (2001), p. 107-120
- [EU11] EU Commission: Commission Regulation (EU) No 10/2011 on plastic materials and articles intended to come into contact with food. Luxembourg: Official Journal of the European Union, 2011
- [EU 22] EU Commission: Commission Regulation (EU) 2022/1616 of 15 September 2022 on recycled plastic materials and articles intended to come into contact with foods, and repealing Regulation (EC) No 282/2008. Luxembourg: Official Journal of the European Union, 2022
- [EU 23] EU Commission: Commission Regulation (EC) No 2023/2006 of 22 December 2006 on good manufacturing practice for materials and articles intended to come into contact with food. Luxembourg: Official Journal of the European Union, 2023
- [FHP94] Franz, R.; Huber, M.; Piringer, O. G.: Testing and evaluation of recycled plastics for food packaging use – possible migration through a functional barrier. *Food additives and contaminants* 11 (1994) 4, p. 479-496
- [Foo21] Food and Drug Administration: Guidance for Industry: Use of Recycled Plastics in Food Packaging (Chemistry Considerations). Maryland: Food and Drug Administration, 2021
- [Fra05] Franz, R.: Migration modelling from food-contact plastics into foodstuffs as a new tool for consumer exposure estimation. *Food additives and contaminants* 22 (2005) 10, p. 920-937
- [FW22] Franz, R.; Welle, R.: Recycling of Post-Consumer Packaging Materials into New Food Packaging Applications – Critical Review of the European Approach and Future Perspectives. *Sustainability* 14 (2022), p. 1-26
- [GPSB23] Ganesan, A.; Preetha, H.; Subathara, S.; Bhowmik, S.: Comparative analysis of carbon emission from products of virgin plastics and recycled plastics and their environmental benefits. *International Journal of Environmental Science and Technology* 20 (2023) 6, p. 6713-6722
- [JHB+17] Jaritz, M.; Hopmann, C.; Behm, H.; Kirchheim, D.; Wilski, S.; Grochla, D.; Banko, L.; Ludwig, A.; Böke, M.; Winter, J.; Bahre, H.; Dahlmann, R.: Influence of residual stress on the adhesion and surface morphology of PECVD-coated polypropylene. *Journal of Physics D: Applied Physics* 50 (2017) 44, p. 445301
- [KBD22] Kleines, L.; Blasius, T.; Dahlmann, R.: PECVD barrier coating systems on post-consumer recyclates for food contact applications. *Surface Engineering* 38 (2022) 10-12, p. 968-976
- [OLH+21] Ouyang, X.; Lu, Z.; Hu, Y.; Xie, Z.; Li, G.: Research progress on sample pre-treatment methods for migratin substances from food contact materials. *Journal of separation science* 44 (2021) 4, p. 879-894

[Pfa22] Pfaendner, R.: Restabilization – 30 years of research for quality improvement of recycled plastics review. *Polymer Degradation and Stability* 203 (2022), p. 110082

[PLA22] PLASTICS EUROPE AISBL: Plastics – the Facts 2022. Article, 2022

[Pre10] Premkumar, P.A.; Starostin, S.A.; Creatore, M.; De Vries, H.; Paffen, R. M. J.; Koenraad, P.M.; Van de Sanden, M.C.M.: Smooth and Self-Similar SiO<sub>2</sub> – like Films on Polymers Synthesized in Roo-to-Roll Atmospheric Pressure-PECVD for Gas Diffusion Barrier Applications. *Plasma Processes and Polymers* 7 (2010), p. 635-639

[PWNC22] Paiva, R.; Wrona, M.; Nerin, C.; Cruz, S. A.: Hydrogenated amorphous carbon film deposited by plasma on recycled polypropylene as a functional barrier to hazardous migrants. *Food Packaging and Shelf Life* 33 (2022), p. 100864

[RBS09] Raffael, B.; Bratinova, S.; Simoneau, C.: Guidelines for performance criteria and validation procedures of analytical methods used in controls of food contact materials: OPOCE, 2009

[RDv17] Ragaert, K.; Delva, L.; Van Geem, K.: Mechanical and chemical recycling of solid plastic waste. *Waste management (New York, N.Y.)* 69 (2017), p. 24-58

[SHT+23] Snyders, R.; Hegemann, D.; Thiry, D.; Zabeida, O.; Klemberg-Sapieha, J.; Martinu, L.: Foundations of plasma enhanced chemical vapor deposition of functional coatings. *Plasma Sources Science and Technology* 32 (2023) 7, p. 074001

[SS21] Schyns, Z. O. G.; Shaver, M. P.: Mechanical Recycling of Packaging Plastics: A Review. *Macromolecular rapid communications* 42 (2021) 3, p. e2000415

[STB+23] Saleem, J.; Tahir, F.; Baig, M. Z. K.; Al-Ansari, T.; McKay, G.: Assessing the environmental footprint of recycled plastic pellets: A life-cycle assessment perspective. *Environmental Technology & Innovation* 32 (2023), p. 103289

[SWB07] Sinclair, C. R.; Watson, D. H.; Barnes, K. A.: *Chemical migration and food contact materials*. 2007

[UGPv23] Undas, A. K.; Groenen, M.; Peters, R. J. B.; Van Leeuwen, S. P. J.: Safety of recycled plastics and textiles: Review on the detection, identification and safety assessment of contaminants. *Chemosphere* 312 (2023) 1, p. 137175

[VPA+22] Vassallo, E.; Pedroni, M.; Aloisio, M.; Chen, H.; Firpo, G.; Pietralunga, S. M.; Ripamonti, D.: Plasma Desposition to Improve Barrier Performance of Biodegradable and Recyclable Substrates Intended for Food Packaging. *Plasma* 5 (2022) 4, p. 451-461

[WF08] Welle, F.; Franz, R.: SiO<sub>x</sub> layer as functional barrier in Polyethylene terephthalate (PET) bottles against potential contaminants from post-consumer recycled PET. *Food Additives and Contaminants: Part A* 25 (2008) 6, p. 788-794

[WF11] Welle, R.; Franz, R.: SiO<sub>x</sub> layer as functional barrier for PET bottles towards potential contaminants from post-consumer recycled poly(ethylene terephthalate). *Food Additives and Contaminants* 25 (2011), p. 788-794

[YLC+21] Yi, K.; Liu, D.; Chen, X.; Yang, J.; Wie, D.; Liu, Y.; Wie, D.: Plasma-Enhanced Chemical Vapor Deposition of Two-Dimensional Materials for Applications. *Accounts of chemical research* 54 (2021) 4, p. 1011-1022

### Abbreviations

Notation	Description
DTG	Derivative thermogravimetry
EFSA	European Food and Safety Authority
FDA	U.S. Food and Drug Administration
GC/MS	Gas chromatography coupled mass spectrometry
PCR	Post consumer recyclates
PECVD	Plasma enhanced chemical vapor deposition
PP	Polypropylene
SiOCH	Organosilicon
SiO <sub>x</sub>	Silicon oxide

Secondary publication of the paper presented at 32nd International Colloquium Plastics Technology, Institute for Plastics Processing (IKV) in Industry and Craft at RWTH-Aachen University, 28-29 February 2024, Aachen Germany

# SMART EXTRUSION

**THE SPECIALIZED WEBPORTAL  
ON EXTRUSION  
FOR EVERY MODERN NEED**

**VM** Verlag GmbH  
Cologne, Germany



[www.smart-extrusion.com](http://www.smart-extrusion.com)

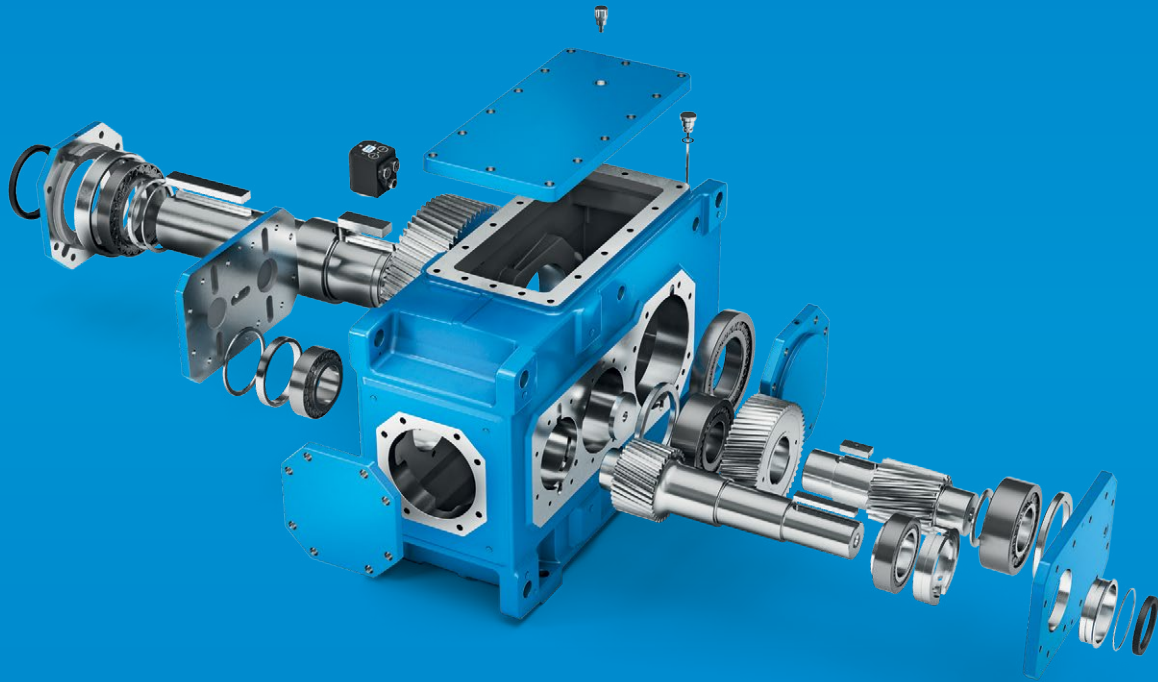

ORIGINAL  
SERVICES.



[flender.com](https://www.flender.com)

**FLENDER**